

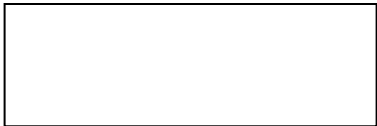
# EOM

ENGINEERING OPERATION  
& MAINTENANCE MANUAL

# P4 Clamped Metal Pump



Where Innovation Flows



### **Copyright**

Copyright 2018 PSG®, a Dover Company. All rights reserved.

PSG reserves the right to modify the information and illustrations in this document without prior notice. The product described in this document is furnished under a license agreement or nondisclosure agreement. No part of this document may be reproduced, stored in a retrieval system, or transmitted in any form or any means electronic or mechanical, including photocopying and recording, without the written permission of PSG, a Dover Company, except as described by the terms of those agreements.

This is a non-contractual document.

### **Trademarks**

PSG and the PSG logo are registered trademarks of PSG. Wilden® is a registered trademark of PSG California LLC. Pro-Flo® SHIFT, Pro-Flo®, and Wil-Flex® are registered trademarks of PSG California LLC. Chem-Fuse™, Pure-Fuse™, Saniflex™, and Bunalast™ are trademarks of PSG California LLC.

All trademarks, names, logos and service marks (collectively “trademarks”) in this document are registered and unregistered trademarks of their respective owners. Nothing contained in this document should be construed as granting any license or right to use any trademark without the prior written permission of the trademark owner.

### **Warranty**

Each and every product manufactured by Wilden is built to meet the highest standards of quality. Every pump is functionally tested to ensure integrity of operation. Wilden warrants that pumps, accessories and parts manufactured or supplied by it to be free from defects in material and workmanship for a period of five (5) years from date of installation or six (6) years from date of manufacture, whichever comes first.

For more information, and to register your Wilden pump for warranty, please visit <https://www.psgdover.com/wilden/support/warranty-registration>.

### **Certifications**



**CONTENTS**

**SECTION 1: Precautions – Read First!** ..... 4

**SECTION 2: Wilden Pump Designation System** ..... 5

**SECTION 3: How It Works** ..... 6

**SECTION 4: Dimensional Drawings** ..... 7

**SECTION 5: Performance** ..... 8

    P4 Metal Rubber-Fitted ..... 8

    P4 Metal TPE-Fitted ..... 8

    P4 Metal Reduced-Stroke PTFE-Fitted ..... 9

    P4 Metal Full-Stroke PTFE-Fitted ..... 9

    P4 Metal Ultra-Flex™ Fitted ..... 10

    Suction Lift Capability ..... 11

**SECTION 6: Suggested Installation, Operation, Maintenance, and Troubleshooting** ..... 12

**SECTION 7: Disassembly/Reassembly** ..... 15

    Pump Disassembly ..... 15

    Air Valve Disassembly ..... 18

    Reassembly Hints and Tips ..... 20

    Gasket Kit Installation ..... 22

**SECTION 8: Exploded View and Parts List** ..... 23

**SECTION 9: Elastomer Options** ..... 29

**SECTION 1**

**PRECAUTIONS – READ FIRST!**



**WARNING:** Always wear safety glasses when operating a pump to avoid eye injury. If diaphragm rupture occurs, material being pumped may be forced out of the air exhaust.



**CAUTION:** Do not apply compressed air to the exhaust port – pump will not function.



**CAUTION:** Do not over-lubricate air supply– excess lubrication will reduce pump performance. Pump is pre-lubed.



**TEMPERATURE LIMITS:**

Acetal	-29°C to 82°C	-20°F to 180°F
Buna-N <sup>®</sup>	-12°C to 82°C	10°F to 180°F
Bunast <sup>™</sup>	-40°C to 130°C	-40°F to 266°F
Geolast <sup>®</sup>	-40°C to 82°C	-40°F to 180°F
Neoprene	-18°C to 93°C	0°F to 200°F
Nordel <sup>®</sup> EPDM	-51°C to 138°C	-60°F to 280°F
Nylon	-18°C to 93°C	0°F to 200°F
PFA	-7°C to 107°C	45°F to 225°F
Polypropylene	0°C to 79°C	32°F to 175°F
Polyurethane	-12°C to 66°C	10°F to 150°F
PVDF	-12°C to 107°C	10°F to 225°F
Saniflex <sup>™</sup>	-29°C to 104°C	-20°F to 220°F
SIPD PTFE with EPDM-backed	4°C to 137°C	40°F to 280°F
SIPD PTFE with Neoprene-backed	4°C to 93°C	40°F to 200°F
PTFE <sup>1</sup>	4°C to 104°C	40°F to 220°F
FKM	-40°C to 177°C	-40°F to 350°F
Wil-Flex <sup>®</sup>	-40°C to 107°C	-40°F to 225°F

<sup>1</sup>4°C to 149°C (40°F to 300°F) - 13 mm (1/2") and 25 mm (1") models only.

**NOTE:** Not all materials are available for all models. See "Wilden Pump Designation System" material options for your pump.



**CAUTION:** When choosing pump materials, be sure to check the temperature limits for all wetted components. Example: FKM has a maximum limit of 177°C (350°F), but polypropylene has a maximum limit of only 79°C (175°F).



**CAUTION:** Maximum temperature limits are based on mechanical stress only. Certain chemicals will reduce maximum safe operating temperatures significantly. Consult the Chemical Resistance Guide for chemical compatibility and temperature limits.



**CAUTION:** All Wilden pumps are capable of passing solids. Use a strainer on the pump intake to ensure that the pump's rated solids capacity is not exceeded.



**CAUTION:** Do not exceed 8.6 bar (125 psig) air supply pressure.



**CAUTION:** The process fluid and cleaning fluids must be chemically compatible with all wetted pump components. Consult Chemical Resistance Guide.



**CAUTION:** Thoroughly flush pumps before installing them into process lines. Clean and/or sanitize FDA- and USDA- approved pumps before using them.



**CAUTION:** Before attempting any maintenance or repair, disconnect the compressed air line to the pump and allow all air pressure to bleed from the pump. Disconnect all intake, discharge, and air lines. Drain the pump by turning it upside down and allowing any fluid to flow into a suitable container. Be aware of any hazardous effects of contact with your process fluid.



**CAUTION:** Before attaching the air line to the pump, blow out the air line for 10 to 20 seconds to make sure all pipeline debris is clear. Use an in-line air filter. A 5µ (micron) air filter is recommended.



**CAUTION:** Pro-Flo pumps cannot be used in submersible applications.



**CAUTION:** Before installation, tighten all hardware.



**NOTE:** Materials of construction and elastomer material may influence suction lift parameters. Please refer to "Performance" for specifics.



**NOTE:** When installing PTFE diaphragms, it is important to tighten outer pistons simultaneously (turning in opposite directions) to ensure tight fit. (See "Maximum Torque Specifications").



**NOTE:** Some PTFE-fitted pumps come standard from the factory with expanded PTFE gaskets installed in the diaphragm bead of the liquid chamber. PTFE gaskets cannot be re-used.



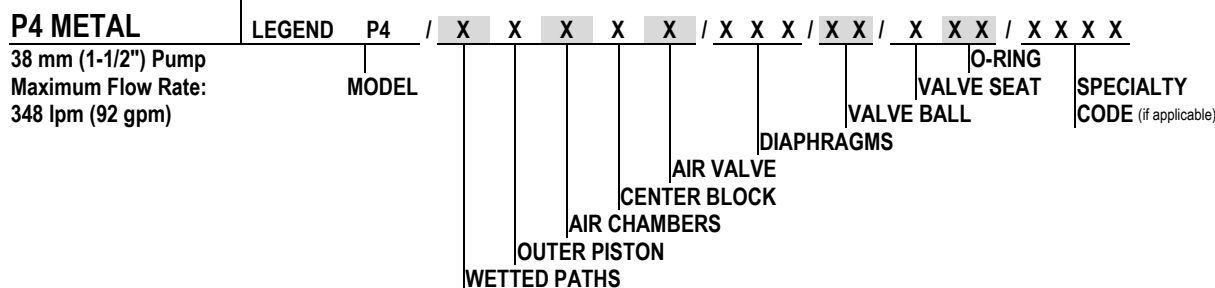
**NOTE:** In the event of a power failure, close the shut-off valve if you do not want the pump to restart when the power returns.



**WARNING:** This product can expose you to chemicals including Nickel, Chromium, Cadmium, or Cobalt, which are known to the State of California to cause cancer and/or birth defects or other reproductive harm. For more information, go to [www.P65Warnings.ca.gov](http://www.P65Warnings.ca.gov).

**SECTION 2**

**WILDEN PUMP DESIGNATION SYSTEM**



**MATERIAL CODES**

**MODEL**

P4 = PRO-FLO<sup>®</sup>

**WETTED PATH**

A = ALUMINUM  
S = STAINLESS STEEL  
W = DUCTILE IRON

**OUTER PISTON**

A = ALUMINUM  
S = STAINLESS STEEL  
M = MILD STEEL  
W = DUCTILE IRON  
Z = NO OUTER PISTON

**AIR CHAMBERS**

A = ALUMINUM  
C = PFA-COATED  
N = NICKEL-PLATED  
S = STAINLESS STEEL  
V = HALAR<sup>®</sup> COATED

**CENTER BLOCK**

N = NICKEL-PLATED  
P = POLYPROPYLENE

**AIR VALVE**

P = POLYPROPYLENE

**DIAPHRAGMS**

BLL = BUNALAST<sup>™</sup> IPD (BLACK)  
BNS = BUNA-N<sup>®</sup> (RED DOT)  
BNU = BUNA-N<sup>®</sup>, ULTRA-FLEX<sup>™</sup> (RED DOT)<sup>1,3</sup>  
EPS = EPDM (BLUE DOT)  
EPU = EPDM, ULTRA-FLEX<sup>™</sup> (BLUE DOT)<sup>1,3</sup>  
FES = SANITARY EPDM<sup>1,3</sup> (TWO BLUE DOTS)  
FSL = FULL-STROKE SANITARY SANIFLEX<sup>™</sup> IPD, [HYTREL<sup>®</sup> (CREAM)]  
FWL = FULL-STROKE SANITARY WIL-FLEX<sup>®</sup>, IPD  
FWS = SANITARY WIL-FLEX<sup>®</sup> EZ-INSTALL [SANTOPRENE<sup>®</sup> (TWO BLACK DOTS)]<sup>1,3</sup>  
NES = NEOPRENE (GREEN DOT)  
NEU = NEOPRENE, ULTRA-FLEX<sup>™</sup> (GREEN DOT)  
SSL = FULL-STROKE SANIFLEX<sup>™</sup> IPD [HYTREL<sup>®</sup> (CREAM)]  
TEU = PTFE W/EPDM BACKUP (WHITE)  
TNU = PTFE W/NEOPRENE BACKUP (WHITE)  
TSS = FULL-STROKE PTFE W/SANIFLEX<sup>™</sup> BACK-UP  
TSU = PTFE W/SANIFLEX<sup>™</sup> BACK-UP (WHITE)  
TWS = FULL-STROKE PTFE W/WIL-FLEX<sup>®</sup> BACK-UP  
VTS = FKM (WHITE DOT)  
VTU = FKM, ULTRA-FLEX<sup>™</sup> (WHITE DOT)  
WWL = WIL-FLEX<sup>®</sup> IPD (SANTOPRENE<sup>®</sup>) (THREE BLACK DOTS)]  
ZGS = BUNALAST<sup>™</sup> EZ-INSTALL (BLACK)  
ZPS = POLYURETHANE, EZ-INSTALL  
ZSS = SANIFLEX<sup>™</sup>, EZ-INSTALL [HYTREL<sup>®</sup>]  
ZWS = WIL-FLE X<sup>®</sup>, EZ-INSTALL [SANTOPRENE<sup>®</sup>]

**VALVE BALLS**

BN = BUNA-N<sup>®</sup> (RED DOT)  
EP = EPDM (BLUE DOT)  
FS = SANIFLEX<sup>™</sup> [HYTREL<sup>®</sup> (CREAM)]<sup>1,3</sup>  
NE = NEOPRENE (GREEN DOT)  
PU = POLYURETHANE (BROWN)  
TF = PTFE (WHITE)  
VT = FKM (SILVER OR WHITE DOT)  
WF = WIL-FLEX<sup>®</sup> [SANTOPRENE<sup>®</sup> (THREE BLACK DOTS)]

**VALVE SEATS**

A = ALUMINUM  
BN = BUNA-N<sup>®</sup> (RED DOT)  
FS = SANIFLEX<sup>™</sup> [HYTREL<sup>®</sup> (CREAM)]<sup>1,3</sup>  
H = ALLOY C  
M = MILD STEEL  
EP = EPDM (BLUE DOT)  
NE = NEOPRENE (GREEN DOT)  
PU = POLYURETHANE (CLEAR)  
S = STAINLESS STEEL  
VT = FKM (SILVER OR WHITE DOT)  
WF = WIL-FLEX<sup>®</sup> (SANTOPRENE<sup>®</sup>)

**VALVE SEATS O-RING**

TF = PTFE<sup>1,2,3</sup>

**SPECIALTY CODES**

014 BSP  
0023 Wing nuts  
0030 Screen based  
0036 Screen based, BSP  
0044 Stallion, balls & seats ONLY  
0047 Stallion externals, balls and seats

0067 Saniflo FDA, Wil-Gard 220V  
0070 Saniflo FDA  
0075 Saniflo FDA, Stallion balls and seats  
0079 Tri-clamp fittings, wing nuts  
0080 Tri-clamp fittings ONLY  
0100 Wil-Gard 110V

0067E Saniflo<sup>™</sup> FDA, Wil-Gard II<sup>™</sup> 220V (1935/2004/EC)  
0070E Saniflo<sup>™</sup> FDA (1935/2004/EC)  
0075E Saniflo<sup>™</sup> FDA, Stallion balls and seats (1935/2004/EC)  
0120E Saniflo<sup>™</sup> FDA, Wil-Gard II<sup>™</sup> 110V (1935/2004/EC)

**REFERENCES:**

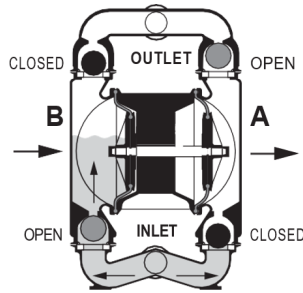
<sup>1</sup> Meets Requirements of FDA CFR21.177  
<sup>2</sup> Meets Requirements of USP Class VI  
<sup>3</sup> Meets Requirements of 1935/2004/EC

**! NOTE:** Most elastomeric materials use colored dots for identification. **! NOTE:** Not all models are available with all material options  
**! NOTE:** ZGS diaphragm material previously known as Geolast<sup>®</sup> has been replaced with Bunalast<sup>™</sup>

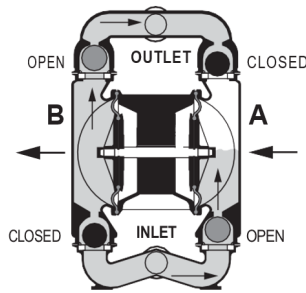
**SECTION 3**

**HOW IT WORKS – AIR-OPERATED DOUBLE-DIAPHRAGM PUMP**

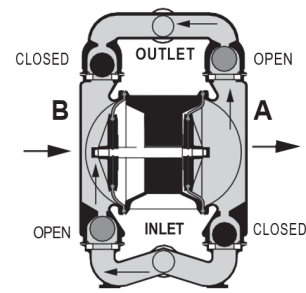
The Wilden diaphragm pump is an air-operated, positive displacement, self-priming pump. These drawings show flow pattern through the pump upon its initial stroke. It is assumed the pump has no fluid in it prior to its initial stroke.



**FIGURE 1** The air valve directs pressurized air to the back side of diaphragm A. The compressed air is applied directly to the liquid column separated by elastomeric diaphragms. The diaphragm acts as a separation membrane between the compressed air and liquid; a balanced load removes mechanical stress from the diaphragm. The compressed air moves the diaphragm away from the center of the pump. The opposite diaphragm is pulled in by the shaft connected to the pressurized diaphragm. Diaphragm B is on its suction stroke; air behind the diaphragm has been forced out to atmosphere through the exhaust port of the pump. The movement of diaphragm B toward the center of the pump creates a vacuum within chamber B. Atmospheric pressure forces fluid into the inlet manifold forcing the inlet valve ball off its seat. Liquid is free to move past the inlet valve ball and fill the liquid chamber (see shaded area).

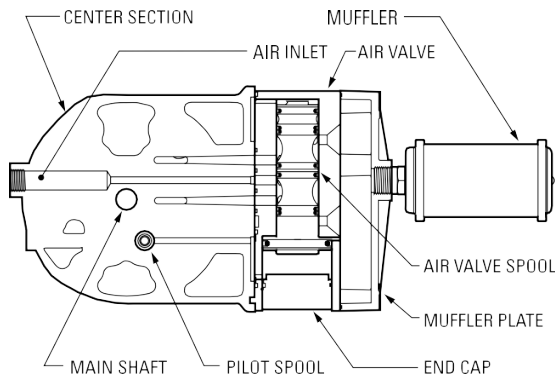


**FIGURE 2** When the pressurized diaphragm, diaphragm A, reaches the limit of its discharge stroke, the air valve redirects pressurized air to the back side of diaphragm B. The pressurized air forces diaphragm B away from the center while pulling diaphragm A to the center. Diaphragm B is now on its discharge stroke. Diaphragm B forces the inlet valve ball onto its seat due to the hydraulic forces developed in the liquid chamber and manifold of the pump. These same hydraulic forces lift the discharge valve ball off its seat, while the opposite discharge valve ball is forced onto its seat, forcing fluid to flow through the pump discharge. The movement of diaphragm A toward the center of the pump creates a vacuum within liquid chamber A. Atmospheric pressure forces fluid into the inlet manifold of the pump. The inlet valve ball is forced off its seat allowing the fluid being pumped to fill the liquid chamber.



**FIGURE 3** At completion of the stroke, the air valve again redirects air to the back side of diaphragm A, which starts diaphragm B on its exhaust stroke. As the pump reaches its original starting point, each diaphragm has gone through one exhaust and one discharge stroke. This constitutes one complete pumping cycle. The pump may take several cycles to completely prime depending on the conditions of the application.

**HOW IT WORKS – AIR DISTRIBUTION SYSTEM**

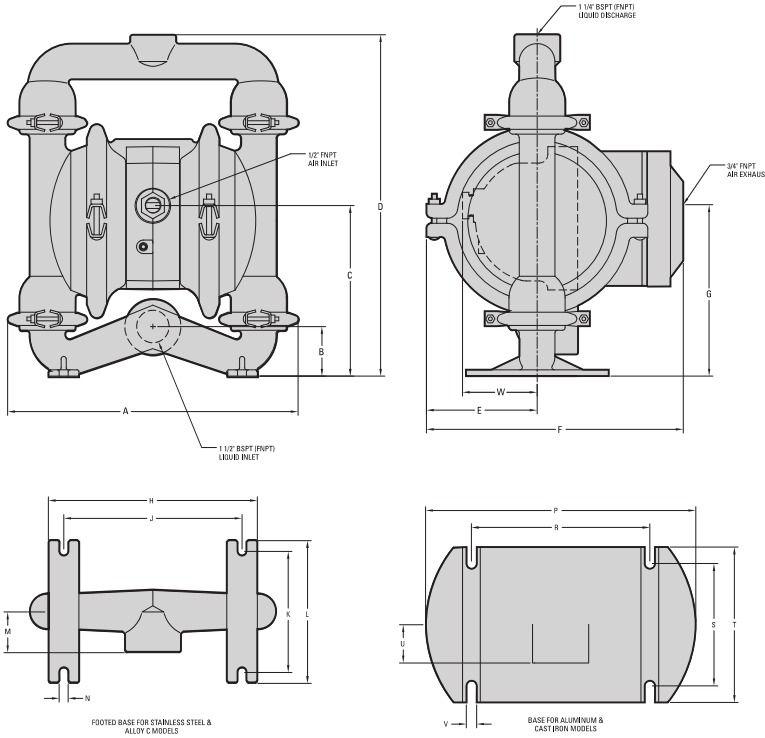


The Pro-Flo® patented air distribution system incorporates two moving parts: the air valve spool and the pilot spool. The heart of the system is the air valve spool and air valve. This valve design incorporates an unbalanced spool. The smaller end of the spool is pressurized continuously, while the large end is alternately pressurized then exhausted to move the spool. The spool directs pressurized air to one air chamber while exhausting the other. The air causes the main shaft/diaphragm assembly to shift to one side — discharging liquid on that side and pulling liquid in on the other side. When the shaft reaches the end of its stroke, the inner piston actuates the pilot spool, which pressurizes and exhausts the large end of the air valve spool. The repositioning of the air valve spool routes the air to the other air chamber

**SECTION 4**

**DIMENSIONAL DRAWING**

**P4 Metal**

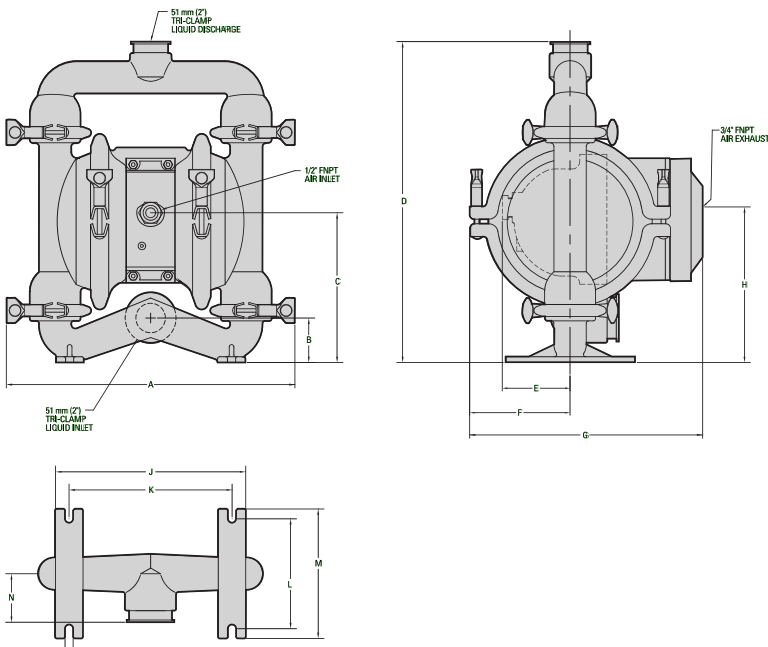


**DIMENSIONS**

ITEM	METRIC (mm)	STANDARD (inch)
A	368	14.5
B	64	2.5
C	206	8.1
D	429	16.9
E	138	5.4
F	320	12.6
G	211	8.3
H	262	10.3
J	224	8.8
K	150	5.9
L	178	7.0
M	51	2.0
N	10	0.4
P	338	13.3
R	224	8.8
S	155	6.1
T	193	7.6
U	48	1.9
V	13	0.5
W	91	3.6

LW0338 REV. A

**P4 Metal Saniflo™ FDA**



**DIMENSIONS**

ITEM	METRIC (mm)	STANDARD (inch)
A	396	15.6
B	64	2.5
C	206	8.1
D	422	17.4
E	91	3.6
F	138	5.4
G	320	12.6
H	211	8.3
J	262	10.3
K	224	8.8
L	152	6.0
M	178	7.0
N	69	2.7
P	10	0.4

LW0339 REV. A

**SECTION 5**

**PERFORMANCE**

**P4 METAL  
RUBBER-FITTED**

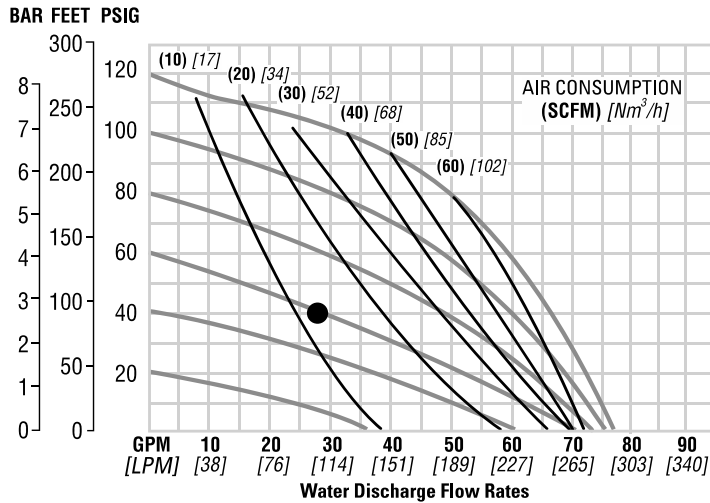
Ship Weights.....Aluminum 13 kg (29 lb)  
 Stainless Steel 20 kg (45 lb)  
 Cast Iron 22 kg (49 lb)  
 Alloy C 23 kg (51 lb)

Air Inlet.....13 mm (1/2")  
 Inlet.....38 mm (1-1/2")  
 Outlet.....32 mm (1-1/4")  
 Suction Lift.....5.8 m Dry (19.0')  
 8.0 m Wet (26.0')

Disp. per Stroke<sup>1</sup>.....0.98 L (0.26 gal)  
 Max. Flow Rate.....288 lpm (76 gpm)  
 Max. Size Solids.....4.8 mm (3/16")

<sup>1</sup>Displacement per stroke was calculated at 4.8 bar (70 psig) air inlet pressure against a 2.1 bar (30 psig) head pressure.

**Example:** To pump 102 lpm (27 gpm) against a discharge pressure head of 2.7 bar (40 psig) requires 4.1 bar (60 psig) and 22 Nm<sup>3</sup>/h (13 scfm) air consumption.



Flow rates indicated on chart were determined by pumping water. For optimum life and performance, pumps should be specified so that daily operation parameters will fall in the center of the pump's performance curve.

**Caution:** Do not exceed 8.6 bar (125 psig) air supply pressure.

**P4 METAL  
TPE-FITTED**

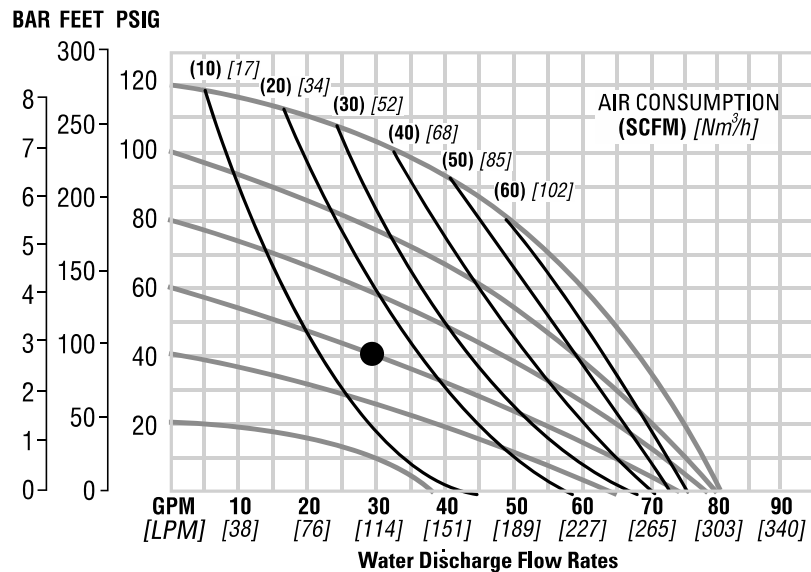
Ship Weights.....Aluminum 13 kg (29 lb)  
 Stainless Steel 20 kg (45 lb)  
 Cast Iron 22 kg (49 lb)  
 Alloy C 23 kg (51 lb)

Air Inlet.....13 mm (1/2")  
 Inlet.....38 mm (1-1/2")  
 Outlet.....32 mm (1-1/4")  
 Suction Lift.....5.2 m Dry (17')  
 8.8 m Wet (29')

Disp. per Stroke<sup>1</sup>.....1.1 L (0.29 gal)  
 Max. Flow Rate.....307 lpm (81 gpm)  
 Max. Size Solids.....4.8 mm (3/16")

<sup>1</sup>Displacement per stroke was calculated at 4.8 bar (70 psig) air inlet pressure against a 2.1 bar (30 psig) head pressure.

**Example:** To pump 114 lpm (30 gpm) against a discharge pressure head of 2.7 bar (40 psig) requires 4.1 bar (60 psig) and 26 Nm<sup>3</sup>/h (15 scfm) air consumption.



Flow rates indicated on chart were determined by pumping water. For optimum life and performance, pumps should be specified so that daily operation parameters will fall in the center of the pump's performance curve.

**Caution:** Do not exceed 8.6 bar (125 psig) air supply pressure.



**PERFORMANCE**

**P4 METAL  
REDUCED-STROKE  
PTFE-FITTED**

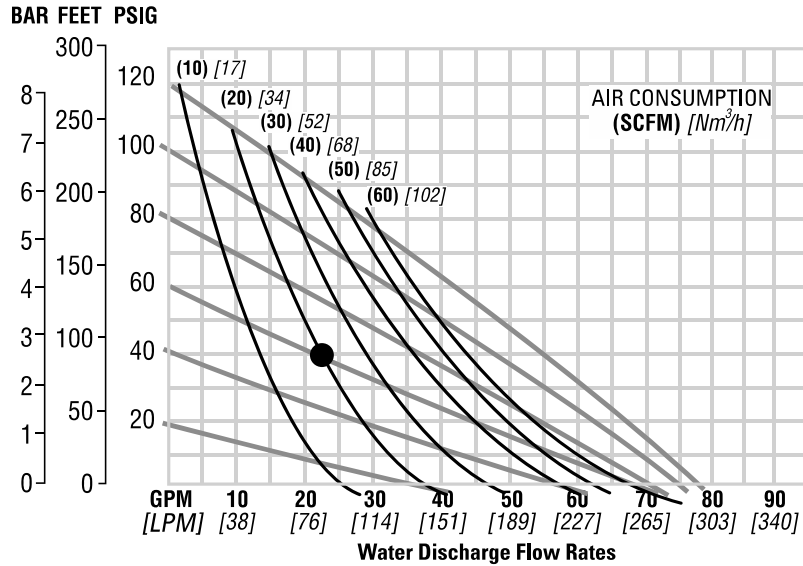
Ship Weights.....Aluminum 13 kg (29 lb)  
Stainless Steel 20 kg (45 lb)  
Cast Iron 22 kg (49 lb)  
Alloy C 23 kg (51 lb)

Air Inlet.....13 mm (1/2")  
Inlet.....38 mm (1-1/2")  
Outlet.....32 mm (1-1/4")  
Suction Lift.....3.7 m Dry (12')  
8.5 m Wet (28')

Disp. per Stroke<sup>1</sup>.....0.53 L (0.14 gal)  
Max. Flow Rate.....295 lpm (78 gpm)  
Max. Size Solids.....4.8 mm (3/16")

<sup>1</sup>Displacement per stroke was calculated at 4.8 bar (70 psig) air inlet pressure against a 2.1 bar (30 psig) head pressure.

**Example:** To pump 83 lpm (22 gpm) against a discharge pressure head of 2.7 bar (40 psig) requires 4.1 bar (60 psig) and 34 Nm<sup>3</sup>/h (20 scfm) air consumption.



Flow rates indicated on chart were determined by pumping water. For optimum life and performance, pumps should be specified so that daily operation parameters will fall in the center of the pump's performance curve.

**Caution:** Do not exceed 8.6 bar (125 psig) air supply pressure.

**P4 METAL  
FULL-STROKE  
PTFE-FITTED**

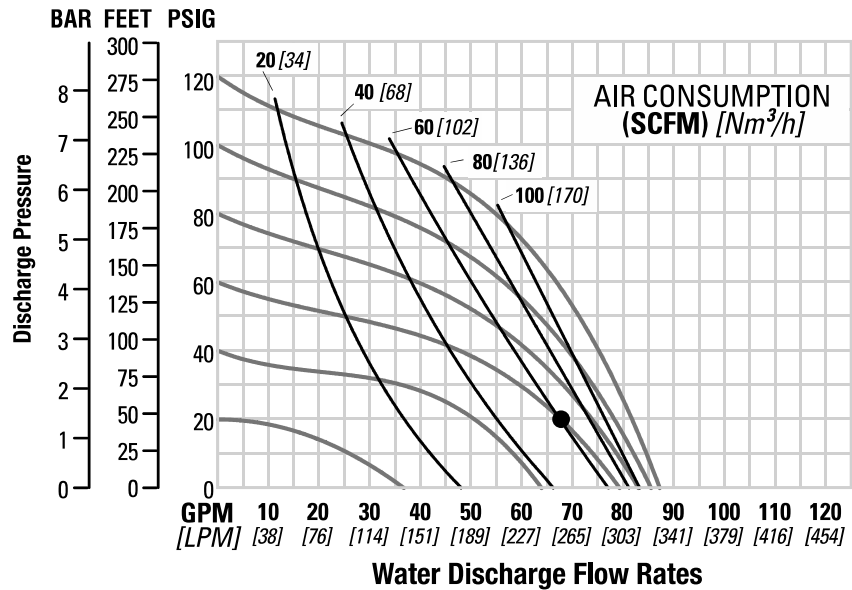
Ship Weights.....Aluminum 13 kg (29 lb)  
Stainless Steel 20 kg (45 lb)  
Cast Iron 22 kg (49 lb)  
Alloy C 23 kg (51 lb)

Air Inlet.....13 mm (1/2")  
Inlet.....38 mm (1-1/2")  
Outlet.....32 mm (1-1/4")  
Suction Lift.....6.4m Dry (21')  
9.3 m Wet (30.6')

Disp. per Stroke<sup>1</sup>.....1.1 L (0.28 gal)  
Max. Flow Rate.....330 lpm (87.2 gpm)  
Max. Size Solids.....4.8 mm (3/16")

<sup>1</sup>Displacement per stroke was calculated at 4.8 bar (70 psig) air inlet pressure against a 2.1 bar (30 psig) head pressure.

**Example:** To pump 257 lpm (68 gpm) against a discharge head of 1.4 bar (20 psig) requires 4.1 bar (60 psig) and 96.5 Nm<sup>3</sup>/h (60 scfm) air consumption.



Flow rates indicated on chart were determined by pumping water. For optimum life and performance, pumps should be specified so that daily operation parameters will fall in the center of the pump's performance curve.

**Caution:** Do not exceed 8.6 bar (125 psig) air supply pressure.

**P4 METAL  
ULTRA-FLEX™-FITTED**

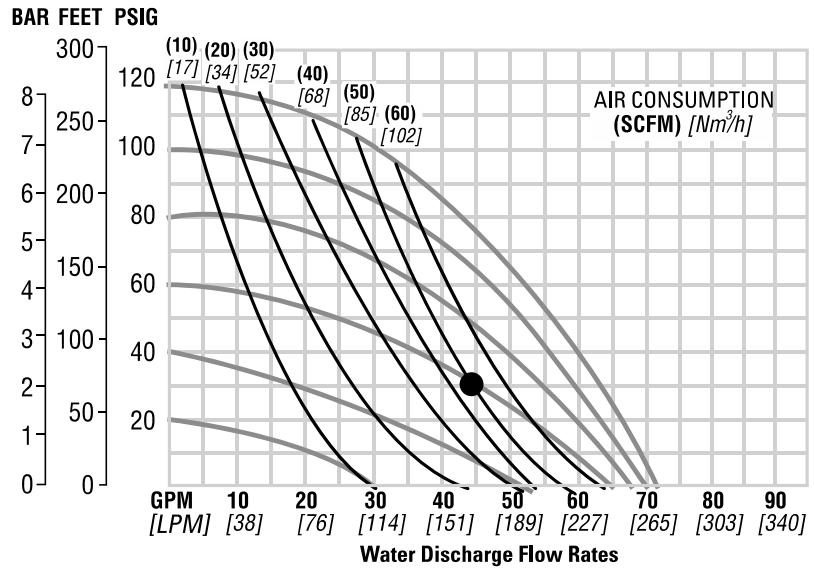
Ship Weights.....Aluminum 13 kg (29 lb)  
                           Stainless Steel 20 kg (45 lb)  
                           Cast Iron 22 kg (49 lb)  
                           Alloy C 23 kg (51 lb)

Air Inlet.....13 mm (1/2")  
 Inlet.....38 mm (1-1/2")  
 Outlet.....32 mm (1-1/4")  
 Suction Lift.....5.2 m Dry (12')  
                           8.5 m Wet (28')

Disp. per Stroke<sup>1</sup>.....0.76 L (0.20 gal)  
 Max. Flow Rate.....269 lpm (71 gpm)  
 Max. Size Solids.....4.8 mm (3/16")

<sup>1</sup>Displacement per stroke was calculated at 4.8 bar (70 psig) air inlet pressure against a 2.1 bar (30 psig) head pressure.

**Example:** To pump 170 lpm (45 gpm) against a discharge pressure head of 2.0 bar (30 psig) requires 4.1 bar (60 psig) and 85 Nm<sup>3</sup>/h (50 scfm) air consumption.



Flow rates indicated on chart were determined by pumping water. For optimum life and performance, pumps should be specified so that daily operation parameters will fall in the center of the pump's performance curve.

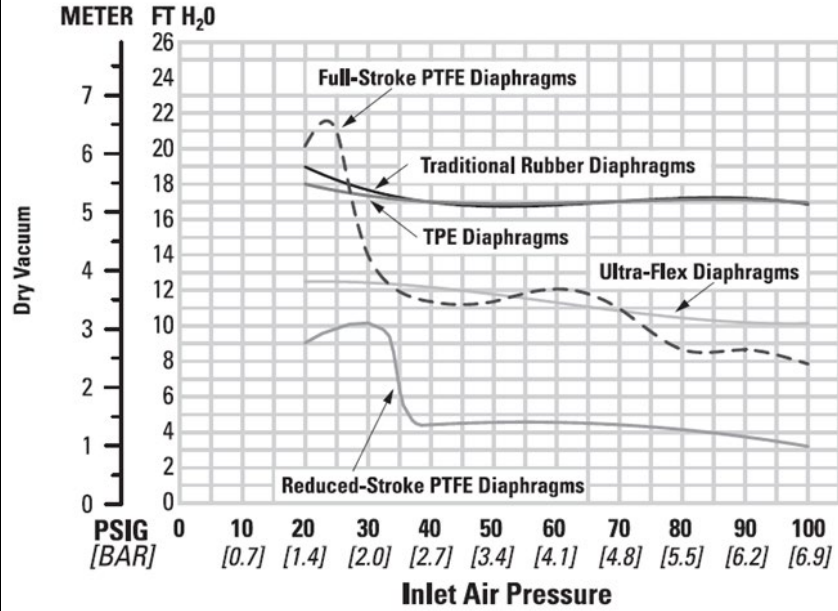
**Caution:** Do not exceed 8.6 bar (125 psig) air supply pressure.

**SECTION 5**

**SUCTION LIFT CAPABILITY**

**P4 METAL SUCTION-LIFT CAPABILITY**

Suction-lift curves are calibrated for pumps operating at 305 m (1,000') above sea level. This chart is meant to be a guide only. There are many variables that can affect your pump's operating characteristics. The number of intake and discharge elbows, viscosity of pumping fluid, elevation (atmospheric pressure) and pipe friction loss all affect the amount of suction lift your pump will attain.




**SECTION 6**

**SUGGESTED INSTALLATION, OPERATION, MAINTENANCE  
AND TROUBLESHOOTING**

Wilden pumps are designed to meet the performance requirements of even the most demanding pumping applications. They have been designed and manufactured to the highest standards and are available in a variety of liquid path materials to meet your chemical resistance needs. Refer to "Performance" for an in-depth analysis of the performance characteristics of your pump. Wilden offers the widest variety of elastomer options in the industry to satisfy temperature, chemical compatibility, abrasion resistance and flex concerns.

The suction pipe size should be at least equal to or larger than the diameter size of the suction inlet on your Wilden pump. The suction hose must be a non-collapsible, reinforced type because these pumps are capable of pulling a high vacuum. Discharge piping should also be equal to or larger than the diameter of the pump discharge, which will help reduce friction losses.

 **CAUTION:** All fittings and connections must be airtight. Otherwise, pump suction capability will be reduced or lost.

Months of careful planning, study and selection efforts can result in unsatisfactory pump performance if installation details are left to chance. You can avoid premature failure and long-term dissatisfaction by exercising reasonable care throughout the installation process.

**Location**

Noise, safety and other logistical factors usually dictate where equipment will be situated on the production floor. Multiple installations with conflicting requirements can result in congestion of utility areas, leaving few choices for additional pumps. Within the framework of these and other existing conditions, locate every pump in such a way that the following six key factors are balanced against each other to maximum advantage:

- **Access:** First, the location should be accessible. If it's easy to reach the pump, maintenance personnel will be able to perform routine inspections and adjustments more easily. If major repairs become necessary, ease of access can play a key role in speeding the repair process and reducing total downtime.
- **Air Supply:** Every pump location should have an air line large enough to supply the volume of air necessary to achieve the desired pumping rate. For best results, the pumps should use a 5µ (micron) air filter, needle valve and regulator. The use of an air filter before the pump will ensure that the majority of any pipeline contaminants will be eliminated.
- **Solenoid Operation:** When operation is controlled by a solenoid valve in the air line, three-way valves should be used. This valve allows trapped air between the valve and the pump to bleed off, which improves pump performance. You can estimate pumping volume by counting the number of strokes per minute, and then multiplying that figure by the displacement per stroke.
- **Muffler:** Using the standard Wilden muffler, sound levels are reduced below OSHA specifications. You can use other mufflers to reduce sound levels farther, but they usually reduce pump performance.
- **Elevation:** Selecting a site that is well within the pump's dynamic lift capability will assure that loss-of-prime issues will


be eliminated. In addition, pump efficiency can be adversely affected if proper attention is not given to site location.

- **Piping:** Final determination of the pump site should not be made until the piping challenges of each possible location have been evaluated. The impact of current and future installations should be considered ahead of time to make sure that inadvertent restrictions are not created for any remaining sites.

The best choice possible will be a site involving the shortest and straightest hook-up of suction and discharge piping. Unnecessary elbows, bends and fittings should be avoided. Pipe sizes should be selected to keep friction losses within practical limits. All piping should be supported independently of the pump. In addition, the piping should be aligned to avoid placing stress on the pump fittings.


Flexible hose can be installed to aid in absorbing the forces created by the natural reciprocating action of the pump. If the pump is to be bolted down to a solid location, a mounting pad placed between the pump and the foundation will assist in minimizing pump vibration. Flexible connections between the pump and rigid piping will also assist in minimizing pump vibration. If quick-closing valves are installed at any point in the discharge system, or if pulsation within a system becomes a problem, a surge suppressor (SD Equalizer) should be installed to protect the pump, piping and gauges from surges and water hammer.


If the pump is to be used in a self-priming application, make sure that all connections are airtight and that the suction lift is within the model's ability.


 **NOTE:** Materials of construction and elastomer material have an effect on suction lift parameters. Please refer to "Performance" for specifics.

When pumps are installed in applications involving flooded suction or suction head pressures, a gate valve should be installed in the suction line to permit closing of the line for pump service.

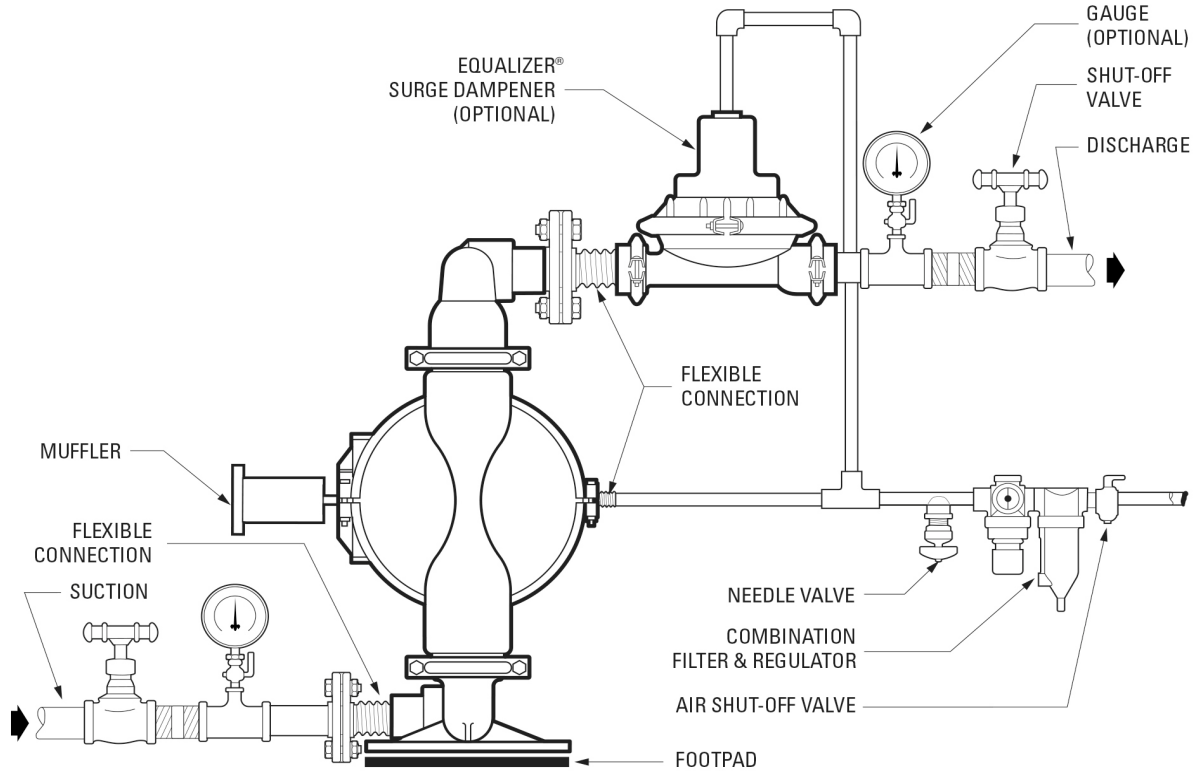
Pumps in service with a positive suction head are most efficient when inlet pressure is limited to 0.5–0.7 bar (7–10 psig). Premature diaphragm failure may occur if positive suction is 0.7 bar (10 psig) and higher.

 **CAUTION:** All Wilden pumps are capable of passing solids. Use a strainer on the pump intake to ensure that the pump's rated solids capacity is not exceeded.

 **CAUTION:** Do not exceed 8.6 bar (125 psig) air supply pressure.

 **CAUTION:** Pro-Flo® pumps do not have single-point exhaust option and are not submersible.

**SUGGESTED INSTALLATION, OPERATION, MAINTENANCE  
AND TROUBLESHOOTING**



**!** **NOTE:** In the event of a power failure, close the shut-off valve if you do not want the pump to restart when the power returns.

**Air-Operated Pumps:** To stop the pump from operating in an emergency, simply close the shut-off valve (user-supplied) installed in the air supply line. A properly functioning valve will stop the air supply to the pump, therefore stopping output. This shut-off valve should be located far enough away from the pumping equipment such that it can be reached safely in an emergency.

**Operation**

The Pro-Flo pumps are pre-lubricated and do not require in-line lubrication. Additional lubrication will not damage the pump. However, if the pump is heavily lubricated by an external source, the pump's internal lubrication maybe washed away. If the pump is then moved to a nonlubricated location, it may need to be disassembled and re-lubricated as described in "Disassembly/ Reassembly".

Pump discharge rate can be controlled by limiting the volume and/or pressure of the air supply to the pump. An air regulator is used to regulate air pressure. A needle valve is used to regulate volume. Pump discharge rate also can be controlled by throttling the pump discharge by partially closing a valve in the discharge line of the pump. This action increases friction loss, which reduces flow rate. (See "Performance") This is useful when the need exists

to control the pump from a remote location. When the pump discharge pressure equals or exceeds the air supply pressure, the pump will stop. No bypass or pressure relief valve is needed, and pump damage will not occur. The pump has reached a "deadhead" situation and can be restarted by reducing the fluid discharge pressure or increasing the air inlet pressure. Wilden Pro-Flo pumps run solely on compressed air and do not generate heat. Therefore, your process fluid temperature will not be affected.

**Maintenance and Inspections**

Because each application is unique, maintenance schedules maybe different for every pump. Frequency of use, line pressure, viscosity and abrasiveness of process fluid all affect the parts life of a Wilden pump. Periodic inspections have been found to offer the best means for preventing unscheduled pump downtime. Personnel familiar with the pump's construction and service should be informed of any abnormalities that are detected during operation.

## SUGGESTED INSTALLATION, OPERATION, MAINTENANCE AND TROUBLESHOOTING

### Troubleshooting

#### ***Pump will not run or runs slowly.***

1. Remove plug from pilot spool exhaust.
2. Ensure that the air inlet pressure is at least 0.4 bar (5 psig) above startup pressure and that the differential pressure (the difference between air inlet and liquid discharge pressures) is not less than 0.7 bar (10 psig).
3. Check air inlet filter for debris (see "Suggested Installation, Operation, Maintenance and Troubleshooting").
4. Check for extreme air leakage (blow by) that would indicate worn seals/bores in the air valve, pilot spool and main shaft.
5. Disassemble the pump and check for obstructions in the air passageways or objects that would obstruct the movement of internal parts.
6. Check for sticking ball check valves.
  - a. If material being pumped is not compatible with pump elastomers, swelling may occur. Replace ball check valves and seals with proper elastomers.
  - b. Also, as the check valve balls wear out, they become smaller and can become stuck in the seats. In this case, replace balls and seats.
7. Check for any broken inner piston that would cause the air valve spool to be unable to shift.

#### ***Pump runs, but little or no product flows.***

1. Check for pump cavitation. Slow pump speed down to allow thick material to flow into liquid chambers.
2. Verify that vacuum required to lift liquid is not greater than the vapor pressure of the material being pumped (cavitation).
3. Check for sticking ball check valves.
  - a. If material being pumped is not compatible with pump elastomers, swelling may occur. Replace ball check valves and seals with proper elastomers.
  - b. Also, as the check valve balls wear out, they become smaller and can become stuck in the seats. In this case, replace balls and seats.

#### ***Pump air valve freezes.***

1. Check for excessive moisture in the compressed air.
  - a. Either install a dryer or a hot air generator for compressed air.
  - b. Alternatively, you may use coalescing filter to remove the water from the compressed air in some applications.

#### ***Air bubbles in pump discharge.***

1. Check for a ruptured diaphragm.
2. Check tightness of outer pistons (see "Disassembly/Reassembly").
3. Check tightness of fasteners and integrity of O-rings and seals, especially at intake manifold.
4. Ensure pipe connections are airtight.

#### ***Product comes out air exhaust.***

1. Check for a diaphragm rupture.
2. Check the tightness of the outer pistons to the shaft.

**SECTION 7**

**DISASSEMBLY / REASSEMBLY**

**PUMP DISASSEMBLY**

**Tools Required:**

- 7/16" Wrench
- 1/2" Wrench
- Adjustable Wrench
- Vise equipped with soft jaws (such as plywood, plastic or other suitable material)



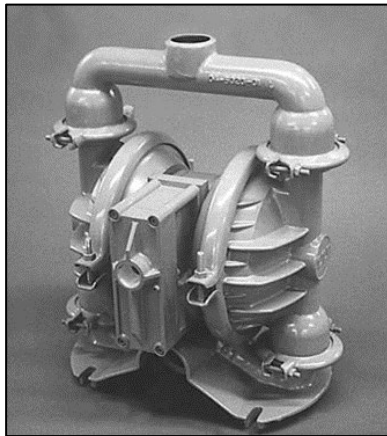
**CAUTION:** Before attempting any maintenance or repair, disconnect the compressed air line to the pump and allow all air pressure to bleed from the pump. Disconnect all intake, discharge, and air lines. Drain the pump by turning it upside down and allowing any fluid to flow into a suitable container. Be aware of any hazardous effects of contact with your process fluid.



**NOTE:** Your specific pump model may vary from the configuration shown; however, pump disassembly procedure will be the same.

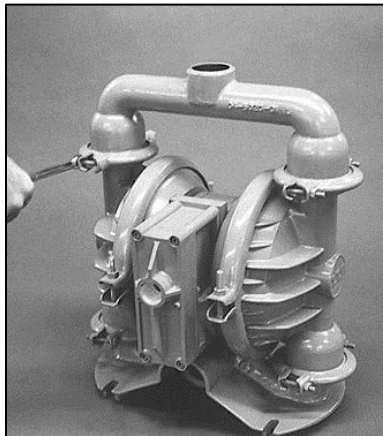


**NOTE:** Replace worn parts with genuine Wilden parts for reliable performance.



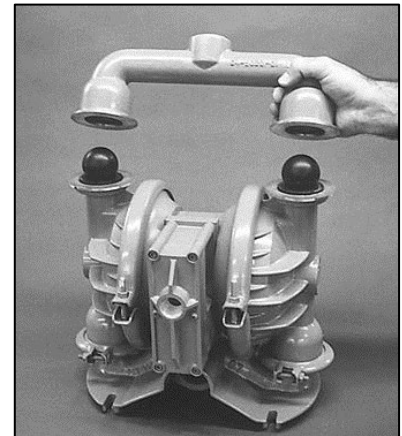
**Step 1**

Before starting disassembly, mark a line from each liquid chamber to its corresponding air chamber. This line will assist in proper alignment during reassembly.



**Step 2**

Using a 7/16" wrench, remove the two (2) small clamp bands that fasten the discharge manifold to the liquid chambers.



**Step 3**

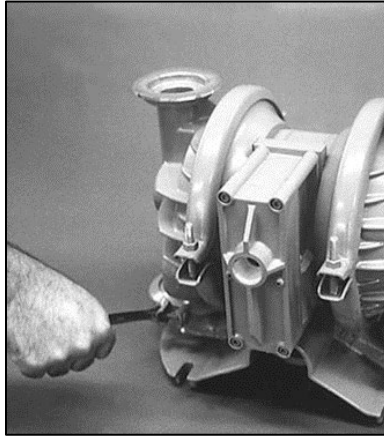
Remove the discharge manifold to expose the valve balls and seats. Inspect ball cage area of manifold for excessive wear or damage.

**DISASSEMBLY / REASSEMBLY**



**Step 4**

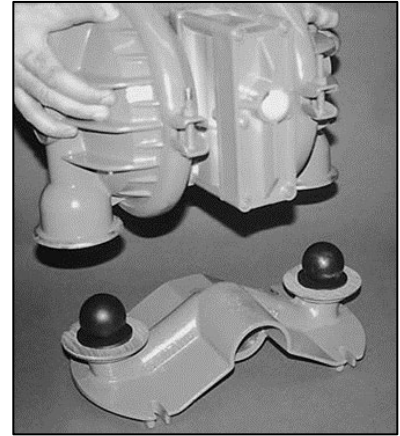
Remove the discharge valve ball, valve seat and valve seat O-ring and inspect for signs of wear and replace, if necessary.



**Step 5**

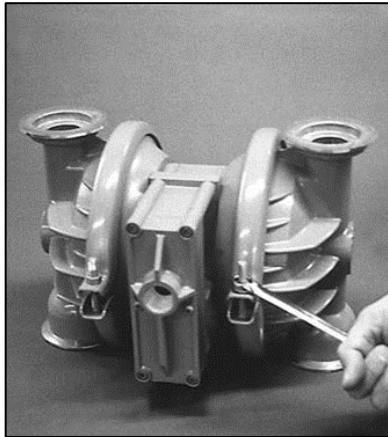
Now the center section assembly can be removed from the inlet manifold.

**NOTE:** Inverting the pump will facilitate removal of inlet manifold.



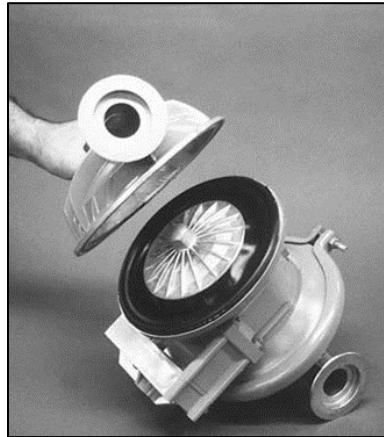
**Step 6**

Remove the inlet valve balls, seats and valve seat O-rings from the liquid chamber and inlet manifold, inspect for nicks, gouges, chemical attack or abrasive wear.



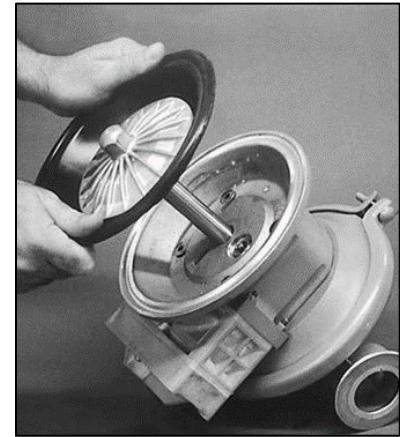
**Step 7**

Remove one (1) set of large clamp bands which secure one (1) liquid chamber to the center section.



**Step 8**

Lift liquid chamber away from center section to expose diaphragm and outer piston.



**Step 9**

Using an adjustable wrench, or by rotating the diaphragm by hand, remove the diaphragm assembly.

**NOTE:** Due to varying torque values, one of the following two situations may occur: 1) The outer piston, diaphragm and inner piston remain attached to the shaft and the entire assembly can be removed from the center section.

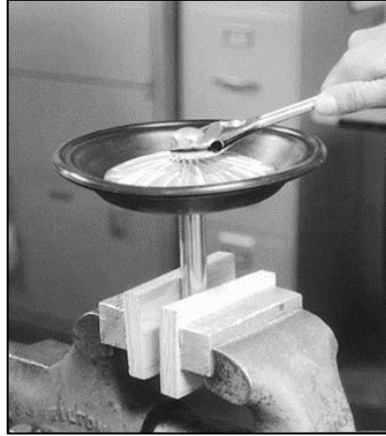


**DISASSEMBLY / REASSEMBLY**



**Step 9B**

2) The outer piston, diaphragm and inner piston separate from the shaft which remains connected to the opposite side diaphragm assembly. Repeat disassembly instructions for the opposite liquid chamber. Inspect diaphragm assembly and shaft for signs of wear or chemical attack. Replace all worn parts with genuine Wilden parts for reliable performance.



**Step 10**

To remove diaphragm assembly from shaft, secure shaft with soft jaws (a vise fitted with plywood, plastic or other suitable material) to ensure shaft is not nicked, scratched or gouged. Using an adjustable wrench, remove diaphragm assembly from shaft.

## DISASSEMBLY / REASSEMBLY

### AIR VALVE DISASSEMBLY

**Tools Required:**

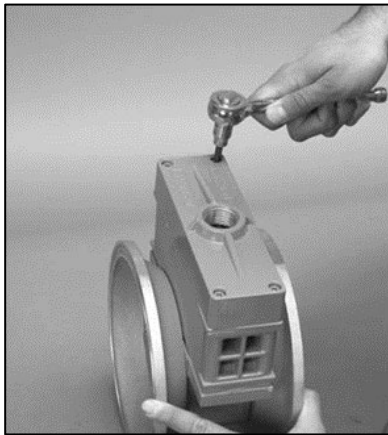
- 3/16" Hex Head Wrench
- 1/4" Hex Head Wrench
- Snap-Ring Pliers
- O-Ring Pick



**CAUTION:** Before attempting any maintenance or repair, disconnect the compressed air line to the pump and allow all air pressure to bleed from the pump. Disconnect all intake, discharge, and air lines. Drain the pump by turning it upside down and allowing any fluid to flow into a suitable container. Be aware of any hazardous effects of contact with your process fluid.

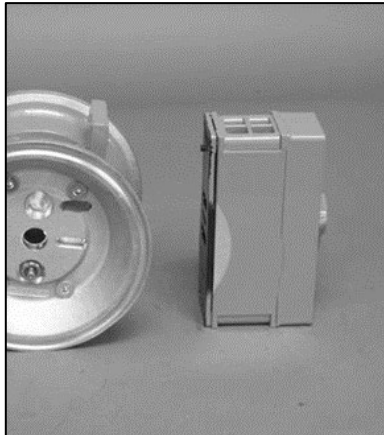


**NOTE:** Replace worn parts with genuine Wilden parts for reliable performance.



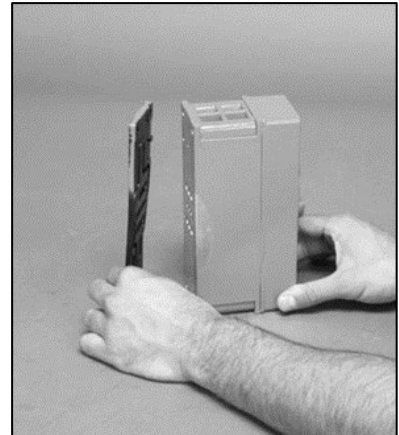
#### **Step 1**

Loosen the air valve bolts utilizing a 3/16" Hex Head wrench.



#### **Step 2**

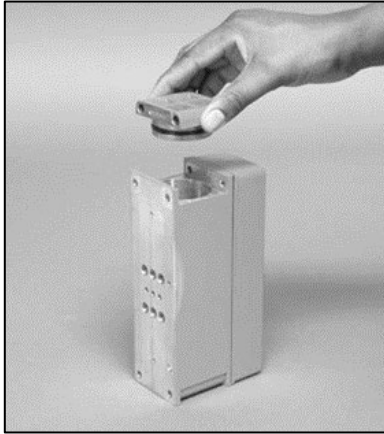
Remove muffer plate and air valve bolts from air valve assembly exposing muffer gasket for inspection. Replace if necessary.



#### **Step 3**

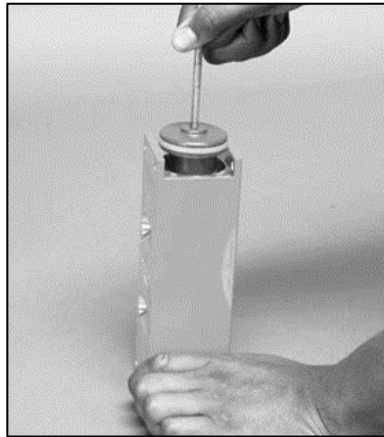
Remove air valve end cap to expose air valve spool.

**DISASSEMBLY / REASSEMBLY**



**Step 4**

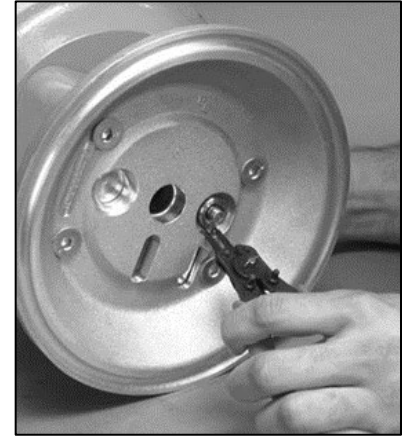
Remove air valve spool from air valve body by threading one air valve bolt into the end of the spool and gently sliding the spool out of the air valve body. Inspect seals for signs of wear and replace entire assembly if necessary. Use caution when handling air valve spool to prevent damaging seals.



**Step 5**

Remove pilot spool sleeve retaining snap ring on both sides of center section with snap ring pliers.

**NOTE:** Seals should not be removed from assembly. Seals are not sold separately.



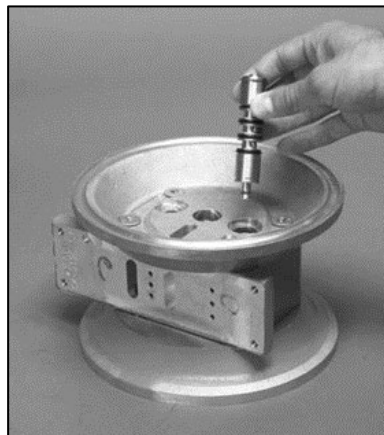
**Step 6**

Remove pilot spool assembly from center section.



**Step 7**

Remove air chamber bolts with 1/4" hex-head wrench.



**Step 8**

Remove pilot spool bushing from center block.

## REASSEMBLY HINTS AND TIPS

Upon performing applicable maintenance to the air distribution system, the pump can now be reassembled. Please refer to the disassembly instructions for photos and parts placement.

To reassemble the pump, follow the disassembly instructions in reverse order. The air distribution system needs to be assembled first, then the diaphragms and finally the wetted path. The applicable torque specifications are on this page.

The following tips will assist in the assembly process:

- Lubricate air valve bore, center section shaft and pilot spool bore with NLGI grade 2 white EP bearing grease or equivalent.
- Clean the inside of the center section shaft bore to ensure no damage is done to new shaft seals.
- A small amount of NLGI grade 2 white EP bearing grease can be applied to the muffler and air valve gaskets to locate gaskets during assembly.
- Make sure that the exhaust port on the muffler plate is centered between the two exhaust ports on the center section.
- Stainless bolts should be lubed to reduce the possibility of seizing during tightening.
- Use a mallet to tamp lightly on the large clamp bands to seat the diaphragm before tightening.

<b>Maximum Torque Specifications</b>	
<b>Description</b>	<b>Torque</b>
Air Valve	5.1 N·m (45 in-lb)
Air Chamber/Center Block	27.1 N·m (20 ft-lb)
Outer Pistons, All	54.2 N·m (40 ft-lb)
Small Clamp Bands	3.4 N·m (30 in-lb)
Large Clamp Bands (Rubber-Fitted)	10.7 N·m (95 in-lb)
Large Clamp Bands (PTFE-Fitted)	13.6 N·m (120 in-lb)

## DISASSEMBLY / REASSEMBLY

### SHAFT SEAL INSTALLATION

#### Pre-Installation

After all the old seals have been removed, the inside of the bushing should be cleaned to ensure no debris is left that may cause premature damage to the new seals.

#### Installation

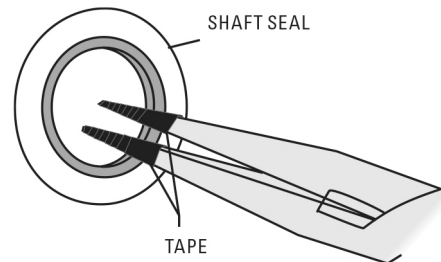
1. To prevent damaging the inside surface of the new seal, wrap electrical tape around each leg of the needle-nose pliers. (Heat shrink tubing may also be used.)
2. With a new seal in hand, place the two legs of the needle-nose pliers inside the seal ring. (See Figure A.)
3. Open the pliers as wide as the seal diameter will allow, then with two fingers pull down on the top portion of the seal to form a kidney bean shape. (See Figure B.)
4. Lightly clamp the pliers together to hold the seal into the kidney shape. Be sure to pull the seal into as tight of a kidney shape as possible. This will allow the seal to travel down the bushing bore with greater ease.
5. With the seal clamped in the pliers, insert the seal into the bushing bore and position the bottom of the seal into the correct groove. When the bottom of the seal is seated in the groove, release the clamp pressure on the pliers. This will allow the seal to partially snap back to its original shape.
6. After removing the pliers, you will notice a slight bump in the seal shape. Before the seal can be resized properly, the bump in the seal should be removed as much as possible. This can be done with either a Phillips screwdriver or your finger. With the side of the screwdriver or your finger, apply light pressure to the peak of the bump. This pressure will cause the bump to be eliminated almost completely.
7. Lubricate the edge of the shaft with NLGI grade 2 white EP bearing grease.
8. Slowly insert the center shaft with a rotating motion. This will complete the resizing of the seal.
9. Repeat these steps for the remaining seals.

#### Tools

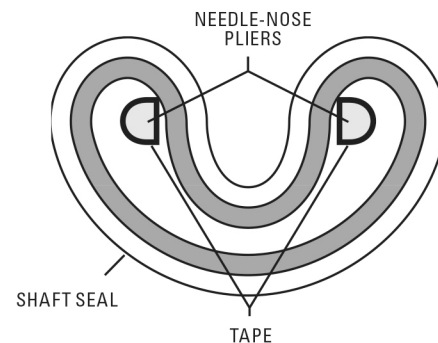
The following tools can be used to aid in the installation of the new seals:

- Needle-Nose Pliers
- Phillips Screwdriver
- Electrical Tape

**Figure A**

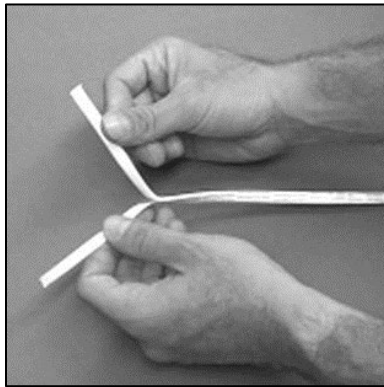


**Figure B**



## GASKET KIT INSTALLATION

Carefully prepare sealing surfaces by removing all debris and foreign matter from diaphragm bead and all mating surfaces. If necessary, smooth or deburr all sealing surfaces. Mating surfaces must be properly aligned in order to ensure positive sealing characteristics.



### **Step 1**

Gently remove the adhesive covering from the back of the PTFE tape. Ensure that the adhesive strip remains attached to the PTFE tape.



### **Step 2**

Starting at any point, place the PTFE tape in the center of the diaphragm bead groove on the liquid chamber and press lightly on the tape to ensure that the adhesive holds in place during assembly. Do not stretch the tape during placement in the center of diaphragm bead groove.



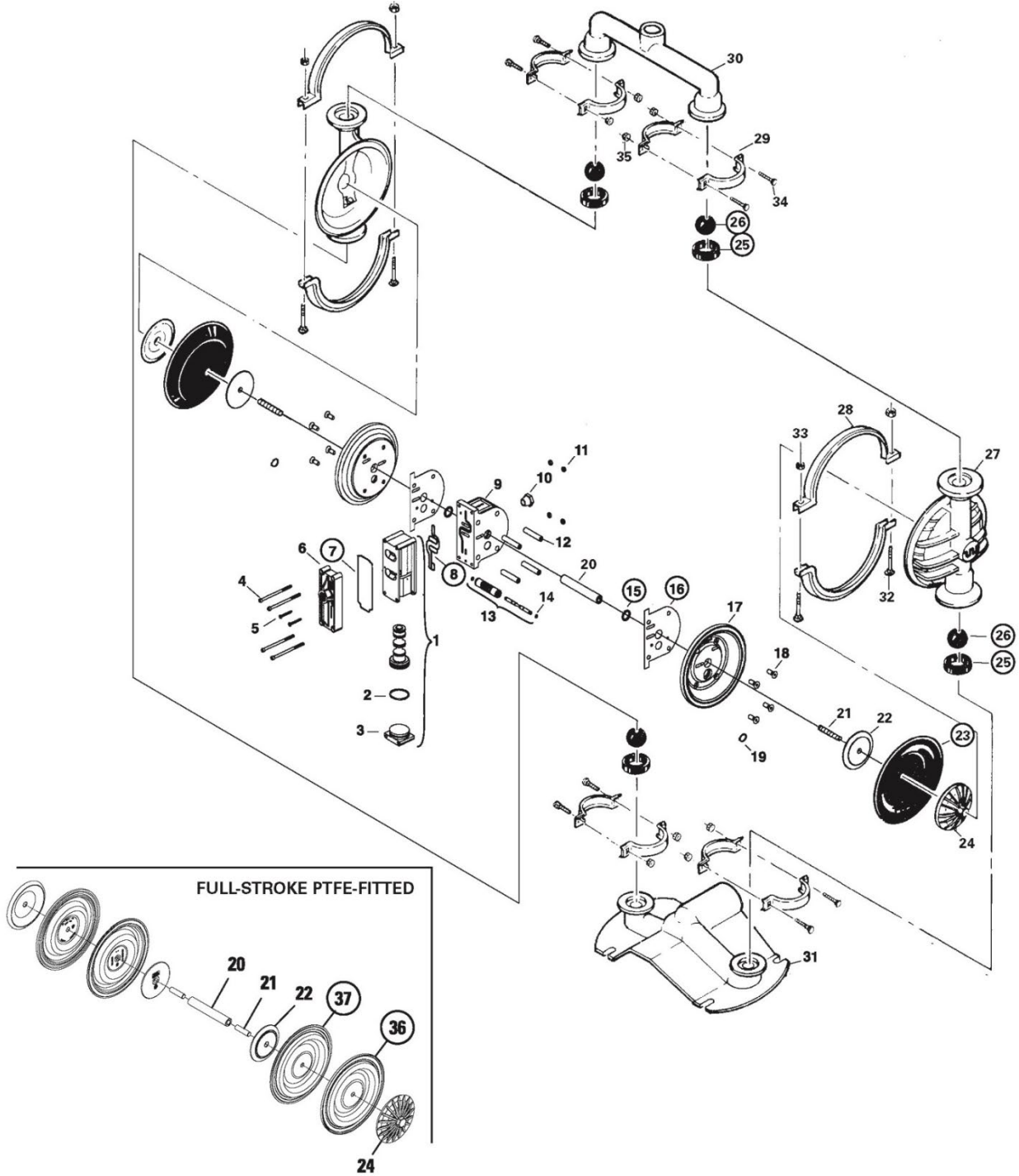
### **Step 3**

The end of the tape should overlap approximately 13 mm (1/2"). Proceed to install the PTFE tape on the remaining diaphragm.

SECTION 8

EXPLODED VIEW AND PARTS LIST

P4 METAL FULL-STROKE DIAPHRAGM-FITTED



ALL CIRCLED PART IDENTIFIERS ARE INCLUDED IN REPAIR KITS

**EXPLODED VIEW AND PARTS LIST**

No.	Part Description	Qty.	P4/AAPP P/N	P4/ WAPP P/N	P4/SAPP P/N	P4/SAPP/070 P/N
1	<b>Pro-Flo® Air Valve Assembly<sup>1</sup></b>	1	<b>04-2000-20-700</b>	<b>04-2000-20-700</b>	<b>04-2000-20-700</b>	<b>04-2000-20-700</b>
2	O-Ring (-225), End Cap (1.859 x .139)	1	04-2390-52-700	04-2390-52-700	04-2390-52-700	04-2390-52-700
3	End Cap, Pro-Flo®	1	04-2330-20-700	04-2330-20-700	04-2330-20-700	04-2330-20-700
4	Screw, HHC, Air Valve (1/4" x 4.5")	4	01-6000-03	01-6000-03	01-6000-03	01-6000-03
5	Screw, SHCS, 10-16 x 1 3/4"	2	04-6351-03	04-6351-03	04-6351-03	04-6351-03
6	Muffler Plate, Pro-Flo®	1	04-3180-20-700	04-3180-20-700	04-3180-20-700	04-3180-20-700
7	<b>Gasket, Muffler Plate</b>	1	<b>04-3500-52-700</b>	<b>04-3500-52-700</b>	<b>04-3500-52-700</b>	<b>04-3500-52-700</b>
8	<b>Gasket, Air Valve</b>	1	<b>04-2600-52-700</b>	<b>04-2600-52-700</b>	<b>04-2600-52-700</b>	<b>04-2600-52-700</b>
9	Center Section Assembly	1	04-3110-20	04-3110-20	04-3110-20	04-3110-20
10	Bushing, Reducer, NPT/BSP Combo	1	04-6950-20-700	04-6950-20-700	04-6950-20-700	04-6950-20-700
11	Nut, Square, 1/4"-20	4	00-6505-03	00-6505-03	00-6505-03	00-6505-03
12	Sleeve, Threaded, Pro-Flo® Center Block	4	04-7710-08	04-7710-08	04-7710-08	04-7710-08
13	<b>Removable Pilot Sleeve Assembly</b>	1	<b>04-3880-99</b>	<b>04-3880-99</b>	<b>04-3880-99</b>	<b>04-3880-99</b>
14	Pilot Spool Retaining O-Ring	2	04-2650-49-700	04-2650-49-700	04-2650-49-700	04-2650-49-700
15	<b>Shaft Seal</b>	2	<b>08-3210-55-225</b>	<b>08-3210-55-225</b>	<b>08-3210-55-225</b>	<b>08-3210-55-225</b>
16	<b>Gasket, Center Block, Pro-Flo®</b>	2	<b>04-3526-52</b>	<b>04-3526-52</b>	<b>04-3526-52</b>	<b>04-3526-52</b>
17	Air Chamber, Pro-Flo®	2	04-3651-01	04-3651-01	04-3651-01	04-3651-01
18	Screw, HSFHS, 3/8"-16 x 1"	8	71-6250-08	71-6250-08	71-6250-08	71-6250-08
19	Retaining Ring	2	04-3890-03	04-3890-03	04-3890-03	04-3890-03
20	Shaft, Pro-Flo®	1	04-3800-03-700	04-3800-03-700	04-3800-03-700	04-3800-03-700
21	Shaft Stud (P4/ WAPP: Bolt) <sup>2</sup>	2	08-6150-08	04-6091-08	08-6150-08	08-6150-08
22	Inner Piston	2	04-3700-01-700	04-3700-01-700	04-3700-01-700	04-3700-01-700
23	<b>Diaphragm</b>	2	*	*	*	<b>04-1010-56</b>
24	Outer Piston	2	04-4552-01	04-4550-08	04-4550-03	04-4550-03P
25	<b>Valve Seat</b>	4	*	*	*	<b>04-1120-56</b>
26	<b>Valve Ball</b>	4	*	*	*	<b>04-1080-56</b>
27	Liquid Chamber	2	04-5000-01	04-5000-02	04-5000-03	04-5000-03P
28	Large Clamp Band Assy.	2	04-7330-08	04-7330-08	04-7330-03	04-7330-03-70P
29	Small Clamp Band Assy.	4	04-7100-08	04-7100-08	04-7100-03	04-7100-03-70P
30	Manifold, Discharge	1	04-5020-01	04-5020-02	04-5020-03	04-5020-03-70
31	Manifold, Footed Inlet	1	04-5080-01	04-5080-02	04-5080-03	04-5080-03-70
32	Carriage Bolt, Large Clamp Band (5/16"-18x2-1/2")	4	04-6070-08	04-6070-08	04-6070-03	04-6070-03
33	Hex Nut, Large Clamp Band (5/16"-18)	4	04-6420-08	04-6420-08	08-6400-03	08-6661-10
34	Carriage Bolt, Small Clamp Band (1/4"-20 x 2")	8	04-6050-08	04-6050-08	01-6070-03	01-6070-03
35	Hex Nut, Small Clamp Band (1/4"-20)	8	04-6400-08	04-6400-08	04-6400-03	04-6651-10
	Muffler (Not Shown)	1	04-3510-99	04-3510-99	04-3510-99	04-3510-99
	Washer, Flat 1/4" (Not Shown)	8				04-6700-07-70
	Washer, Flat 5/16" (Not Shown)	4				08-6700-07-70
36	<b>Diaphragm, Primary Full Stroke PTFE</b>	2	*	*	*	*
37	<b>Diaphragm, Backup Full Stroke PTFE</b>	2	*	*	*	*

<sup>1</sup>Air Valve Assembly includes item numbers 2 and 3.

<sup>2</sup>NOTE: Rubber/TPE-fitted cast iron pumps use 1/2"-20 x 1-1/2" Hex Bolt (P/N 04-6091-08) with washer (P/N 04-6800-08).

BSP-fitted pumps are available. Contact your distributor for part numbers.

For optional P4 Metal Pump elastomers, see Section 9.

NOTE: Aluminum pumps are available with a screen base. Requires (1) 04-5620-01 (Screen), (4) 04-6140-08 (Bolt) and (4) 15-6720-08 (Washer).

-0070 Specialty Code = Saniflo FDA

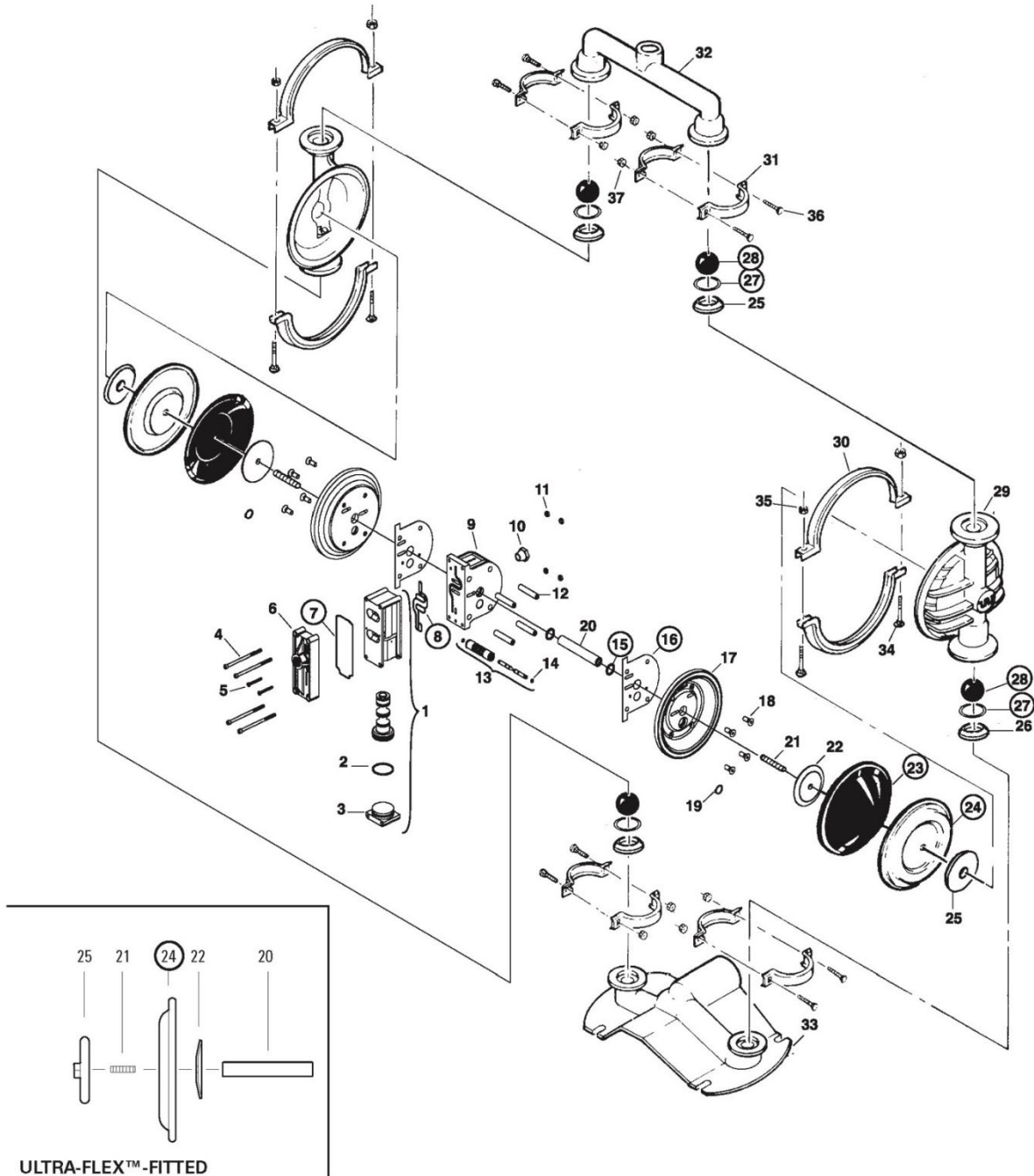
\*See Section 9 — Elastomer Chart

All boldface items are primary wear parts



**EXPLODED VIEW AND PARTS LIST**

**P4 METAL REDUCED-STROKE DIAPHRAGM-FITTED**



ALL CIRCLED PART IDENTIFIERS ARE INCLUDED IN REPAIR KITS

**EXPLODED VIEW AND PARTS LIST**

No.	Part Description	Qty.	P4/AAPP P/N	P4/ WAPP P/N	P4/SAPP P/N	P4/SAPP/0070 P/N
1	Pro-Flo® Air Valve Assembly¹	1	04-2000-20-700	04-2000-20-700	04-2000-20-700	04-2000-20-700
2	O-Ring (-225), End Cap (1.859 x .139)	1	04-2390-52-700	04-2390-52-700	04-2390-52-700	04-2390-52-700
3	End Cap, Pro-Flo®	1	04-2330-20-700	04-2330-20-700	04-2330-20-700	04-2330-20-700
4	Screw, HHC, Air Valve (1/4" x 4.5")	4	01-6000-03	01-6000-03	01-6000-03	01-6000-03
5	Screw, SHCS, 10-16 x 1 3/4"	2	04-6351-03	04-6351-03	04-6351-03	04-6351-03
6	Muffler Plate, Pro-Flo®	1	04-3180-20-700	04-3180-20-700	04-3180-20-700	04-3180-20-700
7	Gasket, Muffler Plate	1	04-3500-52-700	04-3500-52-700	04-3500-52-700	04-3500-52-700
8	Gasket, Air Valve	1	04-2600-52-700	04-2600-52-700	04-2600-52-700	04-2600-52-700
9	Center Section Assembly	1	04-3110-20	04-3110-20	04-3110-20	04-3110-20
10	Bushing, Reducer, NPT/BSP Combo	1	04-6950-23-700	04-6950-23-700	04-6950-23-700	04-6950-23-700
11	Nut, Square, 1/4"-20	4	00-6505-07	00-6505-07	00-6505-07	00-6505-07
12	Sleeve, Threaded, Pro-Flo® Center Block	4	04-7710-08	04-7710-08	04-7710-08	04-7710-08
13	Removable Pilot Sleeve Assembly	1	04-3880-99	04-3880-99	04-3880-99	04-3880-99
14	Pilot Spool Retaining O-Ring	2	04-2650-49-700	04-2650-49-700	04-2650-49-700	04-2650-49-700
15	Shaft Seal	2	08-3210-55-225	08-3210-55-225	08-3210-55-225	08-3210-55-225
16	Gasket, Center Block, Pro-Flo®	2	04-3526-52	04-3526-52	04-3526-52	04-3526-52
17	Air Chamber, Pro-Flo®	2	04-3651-01	04-3651-01	04-3651-01	04-3651-01
18	Screw, HSFHS, 3/8"-16 x 1"	8	71-6250-08	71-6250-08	71-6250-08	71-6250-08
19	Retaining Ring	2	04-3890-03	04-3890-03	04-3890-03	04-3890-03
20	Shaft, Pro-Flo®	1	04-3820-03-700	04-3820-03-700	04-3820-03-700	04-3820-03-700
	Shaft, Pro-Flo®, Ultra-Flex™	1	04-3830-03-700	04-3830-03-700	04-3830-03-700	N/A
21	Stud, Shaft	2	08-6150-08	08-6150-08	08-6150-08	08-6150-08
	Shaft Stud, Ultra-Flex™	2	N/R	04-6152-08	04-6152-08	N/A
22	Inner Piston	2	04-3715-01	04-3715-01	04-3715-01	04-3715-01
	Inner Piston, Ultra-Flex™	2	04-3760-01-700	04-3760-01-700	04-3760-01-700	N/A
23	Back-up Diaphragm	2	*	*	*	*
24	Diaphragm	2	*	*	*	*
25	Outer Piston	2	04-4600-01	04-4600-03	04-4600-03	04-4600-03P
	Outer Piston, Ultra-Flex™	2	04-4560-01	04-4560-02	02-4550-03	N/A
26	Valve Seat	4	04-1121-01	04-1121-08	04-1121-03	04-1121-03P
27	Valve Seat, O-Ring (2.609" x .139")	4	04-1200-55	04-1200-55	04-1200-55	04-1200-55
28	Valve Ball	4	04-1080-55	04-1080-55	04-1080-55	04-1080-55
29	Liquid Chamber	2	04-5000-01	04-5000-02	04-5000-03	04-5000-03P
30	Large Clamp Band Assy.	2	04-7330-03	04-7330-03	04-7330-03	04-7330-03-70
31	Small Clamp Band Assy.	4	04-7100-03	04-7100-03	04-7100-03	04-7100-03-70
32	Manifold, Discharge	1	04-5020-01	04-5020-02	04-5020-03	04-5020-03-70P
33	Manifold, Footed Inlet	1	04-5080-01	04-5080-02	04-5080-03	04-5080-03-70P
34	Carriage Bolt, Large Clamp Band (5/16"-18x2-1/2")	4	04-6070-03	04-6070-03	04-6070-03	04-6070-03
35	Hex Nut, Large Clamp Band (5/16"-18)	4	08-6400-03	08-6400-03	08-6400-03	08-6661-10
36	Carriage Bolt, Small Clamp Band (1/4"-20 x 2")	8	01-6070-03	01-6070-03	01-6070-03	01-6070-03
37	Hex Nut, Small Clamp Band (1/4"-20)	8	04-6400-03	04-6400-03	04-6400-03	04-6651-10
	Muffler (Not Shown)	1	04-3510-99	04-3510-99	04-3510-99	04-3510-99
	Washer, Flat 1/4" (Not Shown)	8				04-6700-07-70
	Washer, Flat 5/16" (Not Shown)	4				08-6700-07-70

¹Air Valve Assembly includes item numbers 2 and 3.

BSP-fitted pumps are available. Contact your distributor for part numbers.

Fluoro-Seal™ O-rings available upon request.

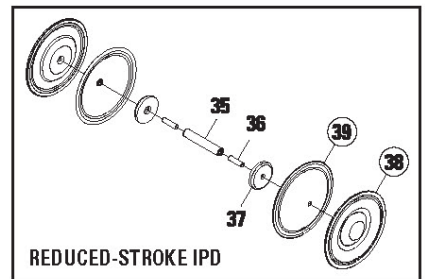
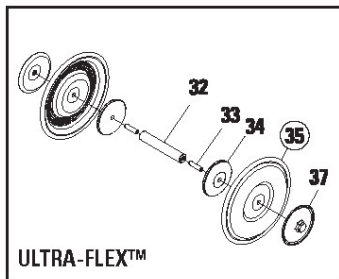
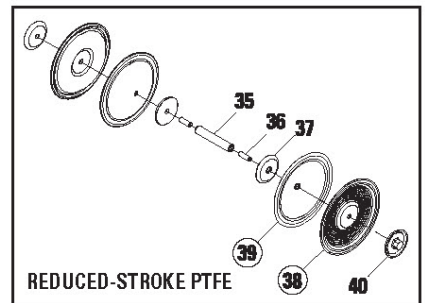
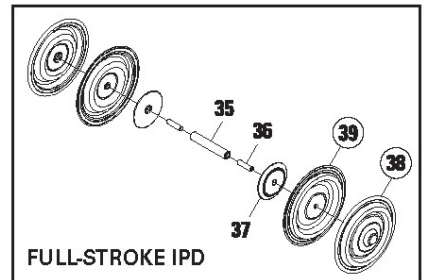
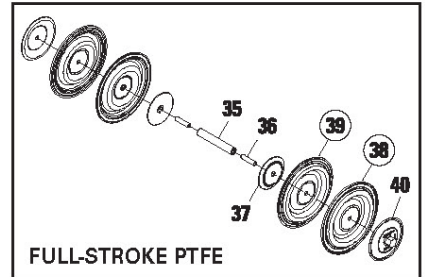
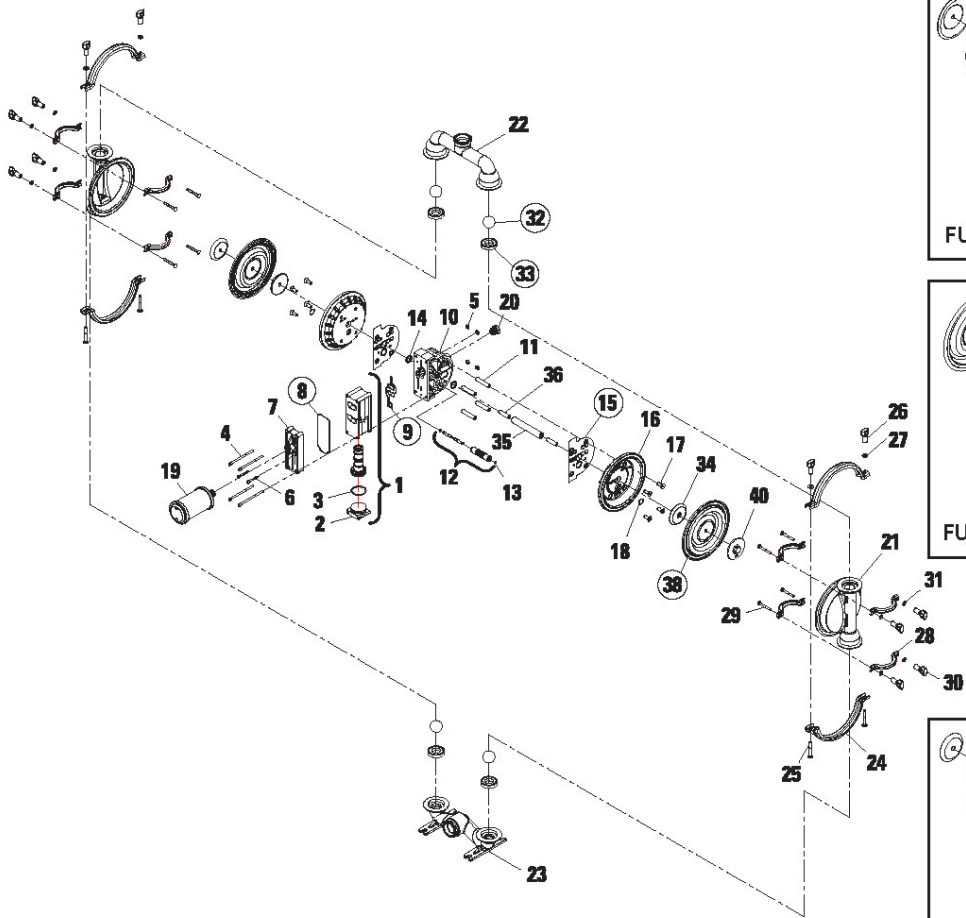
Back-up Diaphragm for PTFE-fitted pump: P/N 04-1060-51. Saniflex™ Back-up Diaphragm, P/N 04-1060-56, is available upon request for PTFE-fitted pumps. Please consult your local distributor.

0070 Specialty Code = Saniflo FDA

All boldface items are primary wear parts.

**EXPLODED VIEW AND PARTS LIST**

**P4 METAL SANIFLO™ FDA**



LW0096 REV. A

ALL CIRCLED PART IDENTIFIERS ARE INCLUDED IN REPAIR KITS

**EXPLODED VIEW AND PARTS LIST**

Item	Description	Qty.	P4/SSPPP/1935/2004/EC
<b>Air Distribution Components</b>			
1	<b>Air Valve Assembly, Pro-Flo 1</b>	1	04-2000-20-700
2	<b>O-Ring, End Cap (-225, Ø1.859" x Ø.139")</b>	1	04-2390-52-700
3	End Cap	1	04-2330-20-700
4	Screw, SHC, Air Valve (1/4"-20 x 4 1/2")	4	01-6000-03
5	Nut, Square (1/4"-20)	4	00-6505-03
6	Self Tapping Screw, SHC, Air Valve (#10-16 x 1-3/4")	2	04-6351-03
7	Muffler Plate, Pro-Flo	1	04-3180-20-700
8	<b>Gasket, Muffler Plate, Pro-Flo</b>	1	04-3500-52-700
9	<b>Gasket, Air Valve, Pro-Flo</b>	1	04-2600-52-700
10	Center Block Assembly, Pro-Flo 2	1	04-3110-20
11	Sleeve, Theraded, Pro-Flo Center Block	4	04-7710-08
12	<b>Pilot Sleeve Assembly</b>	1	04-3880-99
13	<b>O-Ring, Pilot Spool Retaining (-009, Ø.208" x Ø.070")</b>	2	04-2650-49-700
14	<b>Seal, Shaft</b>	2	08-3210-55-225
15	<b>Gasket, Center Block Pro-Flo</b>	2	04-3526-56
16	Air Chamber, Pro-Flo	2	04-3651-01
17	Screw, SFCHC (3/8"-16 x 1")	8	71-6250-08
18	Retaining Ring	2	04-3890-03
19	Muffler 3/4" MNPT	1	04-3510-99R
20	Bushing, Reducer, 3/4" MNPT to 1/2" MNPT	1	04-6950-20-700
<b>Wetted Path Components</b>			
21	Liquid Chamber	2	04-5000-03P
22	Manifold, Discharge Tri-Clamp	1	04-5020-03-70P
23	Manifold, Footed Inlet Tri-Clamp	1	04-5080-03-70P
24	Large Clamp Band Assembly	2	04-7330-03-70
25	RHSN Bolt, Large Clamp Band (5/16"-18 x 2-1/2")	4	04-6070-03
26	Wing Nut, Large Clamp Band (5/16"-18)	4	08-6661-10
27	Washer, Brass Flat (Ø.340" x Ø.750" x .063")	4	08-6700-07-70
28	Small Clamp Band Assembly	8	04-7100-03-70
29	RHSN Bolt, Small Clamp Band (1/4"-20 x 2-1/4")	8	01-6070-03
30	Wing Nut, Small Clamp Band (1/4"-20)	8	04-6651-10
31	Washer, Brass Flat (Ø.251" x Ø.620" x .063")	8	04-6700-07-70
<b>Valve Balls/Valve Seats/Valve O-Rings</b>			
32	<b>Ball, Valve, Pkg 4</b>	1	*
33	<b>Seat, Valve, Pkg 4</b>	1	*
	<b>Seat, Valve, Stainless Steel</b>	4	04-1121-03E
34	<b>O-Ring, Valve Seat (-226, Ø.1.984" x Ø.139"), (Not Shown), Pkg 4</b>	1	04-1200-55E
<b>Full Stroke Rubber/TPE/PTFE Components</b>			
35	Shaft	1	04-3800-03-700
36	Stud, Shaft (1/2"-20 x 1-7/8")	2	08-6150-08
37	Piston, Inner	2	04-3700-01-700
38	<b>Diaphragm, Primary, Pkg 2</b>	1	*
39	<b>Diaphragm, Back-Up, Pkg 2</b>	1	*
40	Piston, Outer	2	04-4550-03P
<b>Ultra-Flex Components</b>			
35	Shaft	1	04-3830-03-700
36	Stud, Shaft (3/8-16 x 1-1/2")	2	04-6152-08
37	Piston, Inner	2	04-3760-01-700
38	<b>Diaphragm Primary, Pkg 2</b>	1	*
39	Piston, Outer	2	02-4550-03P
<b>Reduce Stroke PTFE Components</b>			
35	Shaft	1	04-3820-03-700
36	Stud, Shaft (1/2-20 x 1-7/8")	2	08-6150-08
37	Piston, Inner	2	04-3752-01
38	<b>Diaphragm Primary, Pkg 2</b>	1	*
39	<b>Diaphragm, Back-Up, Pkg 2</b>	1	*
40	Piston, Outer	2	04-4600-03P
<b>Reduce Stroke IPD Components</b>			
35	Shaft	1	04-3820-03-700
36	Stud, Shaft (1/2-20 x 1-7/8")	2	08-6150-08
37	Piston, Inner	2	04-3755-01
38	<b>Diaphragm Primary, Pkg 2</b>	1	*
39	<b>Diaphragm, Back-Up, Pkg 2</b>	1	*
40	Piston, Outer	2	
<b>Full Stroke IPD Components</b>			
35	Shaft	1	04-3800-03-700
36	Stud, Shaft (1/2-20 x 1-7/8")	2	08-6150-08
37	Piston, Inner	2	04-3700-01-700
38	<b>Diaphragm Primary, Pkg 2</b>	1	*
39	<b>Diaphragm, Back-Up, Pkg 2</b>	1	*
40	Piston, Outer	2	

1 Air Valve Assembly includes items 2 and 3.  
 2 Plastic Center Block Assembly includes item 14, and 20.  
 All boldface items are primary wear parts.

**SECTION 9**

**ELASTOMER OPTIONS**

**P4 METAL**

Material	Diaphragms (2)	Ultra-Flex™ Diaphragms (2)	Reduced-Stroke Backup Diaphragms (2)	Full-Stroke Diaphragms (2)	Full-Stroke Backup Diaphragms (2)	EZ-INSTALL DIAPHRAGMS (2)	FULL-STROKE IPD DIAPHRAGMS (2)	Valve Balls (4)	Valve Seats (4)	Valve Seat O-Rings (4)
Neoprene	04-1010-51	04-1020-51	04-1060-51					04-1080-51	04-1120-51*	
Buna-N®	04-1010-52	04-1020-52						04-1080-52	04-1120-52*	
Bunast™						04-1022-57	04-1031-15			
FKM	04-1010-53	04-1020-53						04-1080-53	04-1120-53*	
EPDM	04-1010-54	04-1020-54	04-1060-54					04-1080-54	04-1120-54*	
PTFE	04-1010-55			04-1040-55				04-1080-55		04-1200-55
Full-Stroke PTFE	04-1040-55									
Saniflex™	04-1010-56		04-1060-56		04-1065-56	04-1022-56	04-1031-56	04-1080-56	04-1120-56*	
Non-Food Grade Saniflex™							04-1034-46			
Polyurethane	04-1010-50					04-1022-50		04-1080-50	04-1120-50*	
FDA Wil-Flex®					04-1065-57	04-1022-57	04-1031-57			
Wil-Flex®	04-1010-58					04-1022-58	04-1031-58	04-1080-58	04-1120-58*	
Aluminum									04-1121-01	
Stainless Steel									04-1121-03	
Alloy C									04-1121-04	
Mild Steel									04-1121-08	

LW0084 Rev.C

**P4 METAL SANIFLO™ – 1935 / 2004 / EC**

MATERIAL	DIAPHRAGMS	REDUCED STROKE BACK-UP DIAPHRAGMS	ULTRA-FLEX™ DIAPHRAGMS	FULL STROKE DIAPHRAGMS	FULL STROKE BACK-UP DIAPHRAGMS	EZ-INSTALL DIAPHRAGMS	REDUCED STROKE IPD DIAPHRAGMS	FULL STROKE IPD DIAPHRAGMS	VALVE BALLS	VALVE SEATS
FDA Buna-N®	04-1010-69E		04-1020-52E							
FDA EPDM	04-1010-74E	04-1060-54E	04-1020-54E							
FDA FKM®									08-1080-68-72E	
FDA Wilflex®				04-1040-55E	04-1065-57E	04-1022-57E		04-1031-57E	04-1080-57E	04-1120-57E
SANIFLEX™	04-1010-56E	04-1060-56E			04-1065-56E	04-1022-56E			04-1080-56E	04-1120-56E
PTFE	04-1010-55E						04-1030-72E		04-1080-55E	

LW0084 Rev. C

# WILDEN<sup>®</sup>

## DECLARATION OF CONFORMITY



PSG California LLC, 22069 Van Buren Street, Grand Terrace, CA 92313-5607 USA, certifies as the manufacturer that the Air-Operated Double Diaphragm pumps listed below comply with the following European Community Regulations:

(EC) 1935/2004 for Food Contact Materials  
(EC) 2023/2006 Good Manufacturing Practice  
(EU) 10/2011 on plastic materials and articles intended to come in contact with food

- **25 mm (1") Saniflo Hygienic™ HS Metal Pump:**  
(XPS,PS)2/(SS,SZ)(SSS,NNN)(FBS,FES,FSL,FSS,LEL,TEU,TSS,TSU)(FB,FE,FS,TF)(FB,FE,FV,TF)(0770-0789)E
- **38 mm – 76 mm (1-½"-3") Pro-Flo X Saniflo Hygienic™ HS Metal Pump:**  
(PX,XPX)(4,8,15)/(SS,SZ)(SSS,NNN)(BNU,EPU,FBS,FES,FSL,FSS,LEL,TEU,TSS,TSU,ZSS)(FB,FE,FS,FV,SF,TF,TF,TF)(FB,FE,TF)(0770-0789)E
- **38 mm – 76 mm (1-½"-3") Pro-Flo Shift Saniflo Hygienic™ HS Metal Pump:**  
(PS,XPS)(4,8,15)/(SS,SZ)(SSS,NNN)(FBS,FES,FSL,FSS,LEL,TSS,ZSS)(FB,FE,FS,FV,SF,TF,TF,TF)(FB,FE,TF)(0770-0789)E
- **76 mm (3") Saniflo HS High Pressure Advanced Metal Pump**  
H1500/(SS,SZ)III/(FSL,TSS)(TF,TF)(FE,FV,TF)0770E
- **13 mm (½") Pro-Flo & Pro-Flo X™ Saniflo FDA Metal Pump Models:**  
(P,PX,XPX)1/(SS,SZ)(AAA,GGG,JJJ,LLL,PPP)(FSL,FSS,TEU,TSU)(FS,TF)(S,TF)(0067,0070,0120)E
- **25 mm (1") Pro-Flo Saniflo FDA Metal Pump Models:**  
P2/(SS,SZ)(LLL,PPP)(FBS,FES,FSL,FSS,LEL,TEU,TSS,TSU)(FS,TF)(S,TF)2070E
- **38 mm (1-½") Pro-Flo & Pro-Flo X™ Saniflo FDA Metal Pump Models:**  
(P,PX,XPX)4/(SS,SZ)(AAA,LLL,NNN,SSS)(BNU,EPU,FBS,FES,FSL,FSS,TEU,TSS,TSU)(FS,TF)(FS,STF)(0067,0070,0075,0120)E
- **51 mm (2") Pro-Flo & Pro-Flo X™ Saniflo FDA Metal Pump Models:**  
(P,PX,XPX)8/(SS,SZ)(AAA,PPP,NNN,SSS)(BNU,EPU,FBS,FES,FSS,TEU,TSU,TSS)(FS,TF)(FS,STF)(0070,0075,0120)E
- **76 mm 3" Pro-Flo X™ Saniflo FDA Metal Pump Models:**  
(PX,XPX)15/(SS,SZ)(AAA,NNN,SSS)(BNU,EPU,FSL,FSS,TEU,TSU,TSS)(FS,TF)(FS,STF)(0070,0075,0120)E
- **38 mm 1-½" Pro-Flo Shift™ Saniflo FDA Metal Pump Models:**  
XPS4/(SS,SZ)(AAA,NNN,SSS)(FBS,FES,FSL,FSS,TSS,ZSS)(FS,TF)(FS,STF)(0067,0070,0775,0120)E
- **51 mm 2" Pro-Flo Shift™ Saniflo FDA Metal Pump Models:**  
XPS8/(SS,SZ)(AAA,NNN,SSS)(FBS,FES,FSL,FSS,TSS,ZSS)(FS,TF)(FS,STF)(0070,0075,0120)E
- **76 mm 3" Pro-Flo Shift™ Saniflo FDA Metal Pump Models:**  
XPS15/(SS,SZ)(AAA,NNN,SSS)(FSL,FSS,TSS,ZSS)(FS,TF)(FE,FS,STF)(0070,0120,0341,0770)E

Materials used in equipment that are intended to contact food belong to the groups of materials listed in Annex 1 (EC) 1935/2004 (List of groups of materials and articles which may be covered by specific measures)

5) Rubbers                      8) Metal and Alloy                      10) Plastics

Compliance is subject to material and equipment storage, handling and usage recommended by Wilden in the engineering operation and maintenance manual and supplemental technical publications.

This declaration is based on the following information:

- Statements of raw material from suppliers
- Total Migration Analysis per (EU) 10/2011

Wilden will make available to the competent authorities appropriate documentation to demonstrate compliance

Approved By:

Chris Distaso  
Director of Engineering  
Date: October 10, 2019



**NOTES**

**WILDEN®**

PSG  
22069 Van Buren Street  
Grand Terrace, CA 92313-5651 USA  
P: +1 (909) 422 -1730  
psgdover.com



Where Innovation Flows

---

PSG® reserves the right to modify the information and illustrations contained in this document without prior notice. This is a non-contractual document.